



MAGG

M.R.

QUE BIEN SE VE



MAGG M.R.

QUE BIEN SE VE

ÍNDICE

RESIDENCIAL 3 / 23

DECO	5
CEILING	11
DIAMANTE/APLIQUE	17
CAMPANAS	18
SUSPENDIDOS	19
JARDÍN/SOBREPUESTOS	21
FAROLES	22

RESIDENCIAL - COMERCIAL 25 / 63

HALÓGENO - BAJO VOLTAJE	27
DOWNLIGHT FLUORESCENTE	39
CAMPANAS	49
LINEALES SOBREPONER	50
LINEALES SUSPENDIDOS	57
CANALETAS	59
SUBURBANOS	62
SECURITY	63

COMERCIAL - INDUSTRIAL 65 / 73

OFFICE	67
CAMPANAS	70
LINEALES IP65	71
LINEAL GABINETE	72

75 - 95

LÁMPARAS, BALASTROS Y ACCESORIOS

76	LÁMPARA SHOT MR
76	LÁMPARAS FLUORESCENTES AUTOBALASTRADAS
77	LÁMPARAS FLUORESCENTES COMPACTAS
80	LÁMPARAS DE HALÓGENO
81	LÁMPARAS DE ALTA INTENSIDAD DE DESCARGA (HID)
82	BALASTROS ELECTRÓNICOS FLUORESCENTES
86	BALASTROS ELECTRÓNICOS HID
88	TRANSFORMADORES ELECTROMAGNÉTICOS
89	TRANSFORMADORES ELECTRÓNICOS
90	ARILLOS
92	ACCESORIOS
96	CATEGORÍA IP
97	GLOSARIO
98	ÍNDICE DE CLAVES

SIMBOLOGÍA

 Lámpara Fluorescente Autobalastrada	 Base E26	 Ranura Circular de Plafón (Ø mm)
 Lámpara Fluorescente Autobalastrada Espiral	 Base GU5.3 / GX5.3	 Ranura Cuadrada de Plafón (h x v mm)
 Lámpara Fluorescente Autobalastrada Full Espiral	 Base GU10	
 Lámpara Fluorescente Compacta	 Balastro Electrónico	 Empotrar a Muro
 Lámpara Fluorescente Compacta Espiral	 Balastro Magnético	 Empotrar a Piso
 Lámpara Curvalum	 Transformador Electrónico	 Empotrar a Techo
 Lámpara PL	 Transformador Electromagnético	 Sobreponer a Muro (arbotante)
 Lámpara Fluorescente Circular		 Sobreponer a Piso
 Lámpara FL T5 y T8		 Sobreponer a Techo
 Lámpara Lineal LED	 Voltaje de Corriente Alterna	 Suspendido
 Lámpara	 Voltaje de Corriente Directa	 Apertura
 Lámpara Halógena MR11	 Corriente	 Atenuable
 Lámpara Halógena MR16	 Factor de Potencia	 Haz de Luz
 Lámpara Halógena AR111	 Flujo Luminoso	
 Lámpara AR111 LED	 Frecuencia	 Dirigible
 Lámpara Halógena PAR	 Grado de Protección	 Dirigible Vertical
 Lámpara HID	 Horas de Vida	
 Lámpara Halógeno	 Índice de Reproducción Cromática	 Estaca
 Lámpara de Aditivos Metálicos	 Peso	
 Lámpara de Vapor de Sodio	 Potencia	
 Lámpara MHI base RX7s	 Temperatura de Color	
	 Tensión de Alimentación	

GUÍA DE LECTURA

ACE V4



COLOR	CLAVE
NIQUEL SATÍN	L1020-B10
CHOCOLATE	L1020-B10



ROCK



COLOR	CLAVE
NIQUEL SATÍN	L1006-B10



ROCK P3

Nombre de la luminaria



COLOR	CLAVE
NIQUEL SATÍN	L1030-B10



ROCK V3

Simbología específica

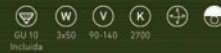

COLOR	CLAVE
NIQUEL SATÍN	L1015-B10



REED

Familia

Sección



COLOR	CLAVE
NIQUEL SATÍN	L1004-B10



RESIDENCIAL / DECO

7

Dimensiones

Claves

Luminaria





RESIDENCIAL

GUÍA RÁPIDA DE LA SECCIÓN

PRODUCTO	LÁMPARA	COLOR	PAG.
	DECO		
	MR16	●	5
STAR			
	MR16	●	5
STAR V3			
	MR16	●	5
DRESS			
	MR16	●	5
DRESS V3			
	MR16	●	5
STONE			
	MR16	●	6
STONE V3			
	MR16	●	6
DUET CL2			
	MR16	●	6
ACE			
	MR16	●	6
ACE P3			
	MR16	●	6
ACE V3			
	MR16	●	7
ACE V4			
	MR16	●	7
ROCK			
	MR16	●	7
ROCK P3			
	MR16	●	7
ROCK V3			

PRODUCTO	LÁMPARA	COLOR	PAG.
	MR16	●	7
REED			
	MR16	●	8
REED V3			
	T13	●	8
SNOW			
	T13	●	8
SNOW P3			
	T13	●	8
SNOW V3			
	T13	●	9
NIX I			
	T13	●	9
NIX II			
	T13	●	9
NIX III			
	T13	●	9
NIX V4			
	MR16	●	10
TECTUM P3			
	MR16	●	10
TECTUM S4			
	T13	●	10
TECTUM i			
	T13	●	10
TECTUM i PLUS			

PRODUCTO	LÁMPARA	COLOR	PAG.
	E26	●	11
PARMA S			
	E26	●	11
PARMA R			
	E26	●	11
PARMA A			
CEILING			
	G10q	●	11
205 Y 305			
	G10q	●	11
250 Y 350			
	G10q	●	12
260 Y 360			
	G10q	●	12
ROUND			
	G10q	●	12
HELIX			
	G10q	●	12
GEMA			
	G10q	●	13
SERIE SQUARE 200			
	G10q	●	13
SERIE SQUARE 300			
	G10q	●	13
SERIE SQUARE 400			
	G10q	●	13
SERIE SQUARE 500			
	G10q	●	14
CEILING STEEL 200			

PRODUCTO	LÁMPARA	COLOR	PAG.
	G10q	●	14
CEILING STEEL 300			
	G10q	●	14
CEILING STEEL 400			
	G10q	●	14
CEILING WOOD 200			
	G10q	●	14
CEILING WOOD 300			
	G10q	●	15
CEILING WOOD 400			
	G10q	●	15
SQUARE WOOD 200			
	G10q	●	15
SQUARE WOOD 500			
	G10q	●	15
SQUARE WOOD 600			

● CHOCOLATE ● NÍQUEL SATÍN ● BLANCO ● CAOBA ● CEREZO

STAR

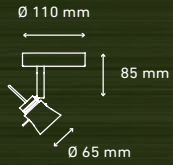

COLOR	CLAVE
NÍQUEL SATÍN	L1001-B10
CHOCOLATE	L1001-810



STAR V3

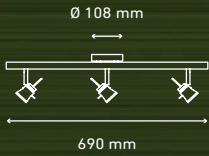

COLOR	CLAVE
NÍQUEL SATÍN	L1010-B10
CHOCOLATE	L1010-810



DRESS

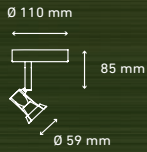

COLOR	CLAVE
NÍQUEL SATÍN	L1002-B10
CHOCOLATE	L1002-810



DRESS V3

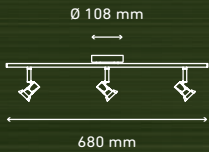

COLOR	CLAVE
NÍQUEL SATÍN	L1011-B10
CHOCOLATE	L1011-810



STONE

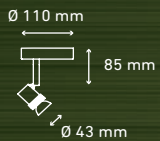

COLOR	CLAVE
NÍQUEL SATÍN	L1003-B10
CHOCOLATE	L1003-810



STONE V3

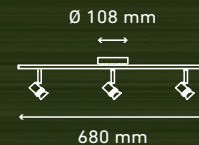

COLOR	CLAVE
NÍQUEL SATÍN	L1012-B10
CHOCOLATE	L1012-810

DUET CL 2

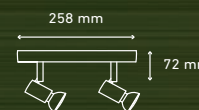

COLOR	CLAVE
NÍQUEL SATÍN	L1040-B10

ACE

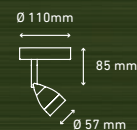

COLOR	CLAVE
NÍQUEL SATÍN	L1005-B10
CHOCOLATE	L1005-810

ACE P3

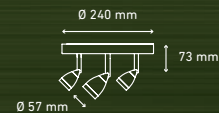

COLOR	CLAVE
NÍQUEL SATÍN	L1031-B10
CHOCOLATE	L1031-810

ACE V3

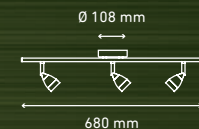

COLOR	CLAVE
NÍQUEL SATÍN	L1014-B10
CHOCOLATE	L1014-810



COLOR	CLAVE
NÍQUEL SATÍN	L1020-B10
CHOCOLATE	L1020-810



ROCK

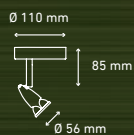

COLOR	CLAVE
NÍQUEL SATÍN	L1006-B10



ROCK P3

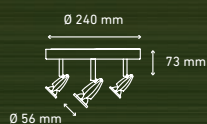

COLOR	CLAVE
NÍQUEL SATÍN	L1030-B10



ROCK V3

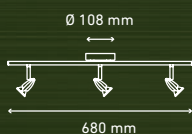

COLOR	CLAVE
NÍQUEL SATÍN	L1015-B10



REED

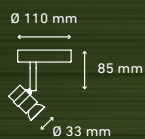

COLOR	CLAVE
NÍQUEL SATÍN	L1004-B10



REED V3



COLOR CLAVE
NÍQUEL SATÍN L1013-B10

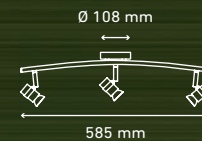

SNOW



COLOR CLAVE
NÍQUEL SATÍN L1007-B10

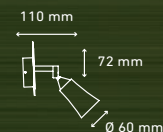

SNOW P3



COLOR CLAVE
NÍQUEL SATÍN L1032-B10

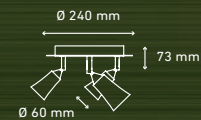

SNOW V3



COLOR CLAVE
NÍQUEL SATÍN L1016-B10

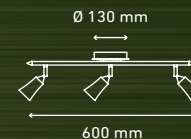

NIX I

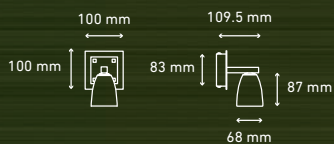

COLOR	CLAVE
BLANCO	L2701-110
CAOBA	L2701-G10
CAOBA / ACERO INOX.	L2701-910
NÍQUEL SATÍN	L2701-B10



NIX II



COLOR	CLAVE
BLANCO	L2702-110
CAOBA	L2702-G10
CAOBA / ACERO INOX.	L2702-910
NÍQUEL SATÍN	L2702-B10



NIX III



COLOR	CLAVE
BLANCO	L2703-110
CAOBA	L2703-G10
CAOBA / ACERO INOX.	L2703-910
NÍQUEL SATÍN	L2703-B10



NIX IV



COLOR	CLAVE
BLANCO	L2704-110



TECTUM P3



COLOR	CLAVE
CAOBA	L2710-G10

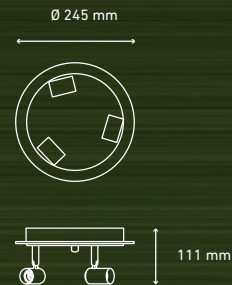

TECTUM S4

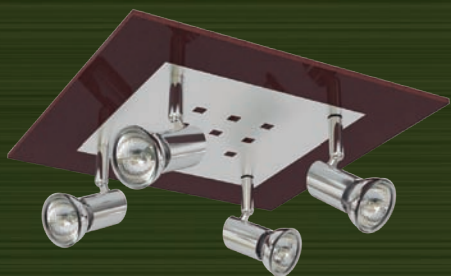

COLOR	CLAVE
CAOBA	L2711-G10

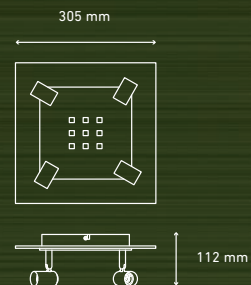

TECTUM *i*



COLOR	CLAVE
CAOBA	L2720-G10

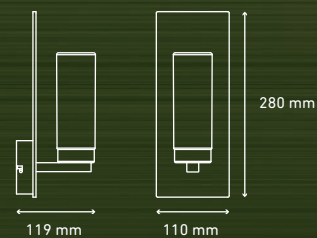

TECTUM *i* PLUS



COLOR	CLAVE
CAOBA / ACERO INOXIDABLE	L2721-910

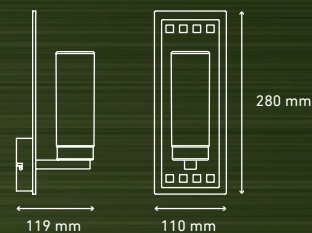

PARMA S

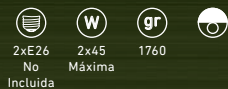
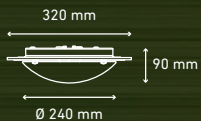

COLOR	CLAVE
CAOBA	L2730-G00



PARMA R

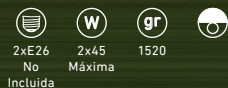
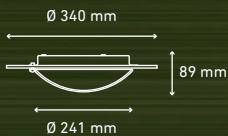

COLOR	CLAVE
CAOBA	L2731-G00



PARMA A

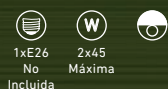
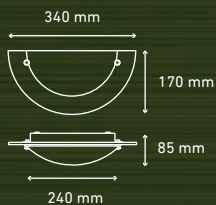

COLOR	CLAVE
CAOBA	L2732-G00



205 Y 305

205

305

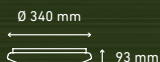
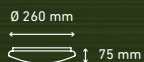

MODELO	W	CLAVE
205	17	L1101-1H0
305	22	L1110-1H0



250 Y 350

250

350

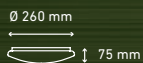

MODELO	W	CLAVE
250	17	L1102-1H0
350	22	L1111-1H0



260 Y 360



MODELO	W	CLAVE
260	17	L1103-1H0
360	22	L1112-1H0

260

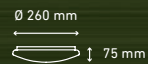

360

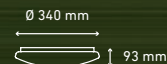

ROUND



COLOR	W	CLAVE
BLANCO	22	L1130-1H0
BLANCO	30	L1133-1H0

22W

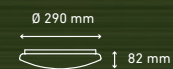

30W



HELIX



COLOR	W	CLAVE
BLANCO	22	L1131-1H0
BLANCO	30	L1134-1H0

22W

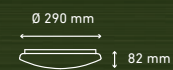

30W

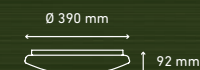

GEMA



COLOR	W	CLAVE
BLANCO	22	L1132-1H0
BLANCO	30	L1135-1H0

22W



30W



SERIE SQUARE 200

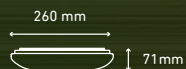

COLOR	K	CLAVE
BLANCO	3000	L1120-1E0
BLANCO	5000	L1120-1H0



SERIE SQUARE 300



COLOR	K	CLAVE
BLANCO	3000	L1121-1E0
BLANCO	5000	L1121-1H0



SERIE SQUARE 400



COLOR	K	CLAVE
BLANCO	3000	L1122-1E0
BLANCO	5000	L1122-1H0



SERIE SQUARE 500



COLOR	CLAVE
BLANCO	L1123-1H0



CEILING STEEL 200



COLOR	CLAVE
NÍQUEL SATÍN	L1140-BH0



CEILING STEEL 300



COLOR	CLAVE
NÍQUEL SATÍN	L1141-BH0



CEILING STEEL 400



COLOR	CLAVE
NÍQUEL SATÍN	L1142-BH0



CEILING WOOD 200



COLOR	K	CLAVE
CEREZO	5000	L1160-FH0
CAOBA	3000	L1160-GE0
CAOBA	5000	L1160-GH0

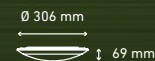

CEILING WOOD 300



COLOR	CLAVE
CEREZO	L1161-FH0
CAOBA	L1161-GH0



CEILING WOOD 400



COLOR	CLAVE
CEREZO	L1162-FH0
CAOBA	L1162-GH0



SQUARE WOOD 400

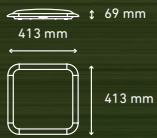

COLOR	CLAVE
CAOBA	L1170-GH0
CEREZO	L1170-FH0



SQUARE WOOD 500

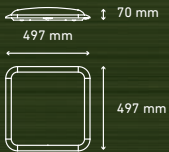

COLOR	CLAVE
CAOBA	L1171-GH0
CEREZO	L1171-FH0





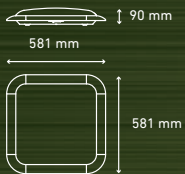

























SQUARE WOOD 600



































COLOR	CLAVE
CAOBA	L1172-GH0



GUÍA RÁPIDA DE LA SECCIÓN

PRODUCTO	LÁMPARA	COLOR	PAG.
APLIQUES			
	T5		17
SERIE B			
	G10q	 	17
S10 PIRÁMIDE			
	G10q	 	17
S20 FLAT			
SUSPENDIDOS			
	E26	 	18
BW 300			
	E26	 	18
BW 350			
	E26	 	18
CAMPANA Z20			
	E26	 	19
GLOBE 6"			
	E26	 	19
GLOBE 8"			
	E26	 	19
GLOBE 10"			
	E26	 	19
GLOBE 12"			

PRODUCTO	LÁMPARA	COLOR	PAG.
	E26	 	19
GLOBE 14"			
	E26	 	19
GLOBE 16"			
	E26	 	20
OVAL 280			
	E26	 	20
OVAL 380			
	E26	 	20
OVAL 480			
	E26	 	20
GLOBE V3			
	E26	 	20
GLOBE V5			
JARDÍN			
	PAR 30/38		21
BREEZE			
	MR16		21
POLO			
	C/FOTO-CELDA	  	21
S/FOTO-CELDA			
TOULOUSE			
		 	21
VERNON			

PRODUCTO	LÁMPARA	COLOR	PAG.
FAROLÉS			
	E26		22
OXFORD			
	E26		22
DOVER			
	E26	  	22
MÉRIDA			
	E26	 	22
TAXCO			
	E26	 	23
SAN MIGUEL			
	E26	 	23
COYOACÁN			
	E26	 	23
QUERÉTARO			
	E26	 	23
GUANAJUATO			

● BLANCO ● NEGRO ○ GRIS ● CHOCOLATE ● NIQUEL SATÍN ● ACERO INOX. ● AZUL

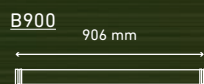

MODELO	W	K	CLAVE
B 600	23	4100	L1210-CF0
B 600	23	6500	L1210-CG0
B 900	34	4100	L1211-CF0
B 900	34	6500	L1211-CG0
B 1200	60	4100	L1212-CF0
B 1200	60	6500	L1212-CG0

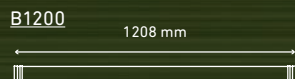

S10 PIRÁMIDE

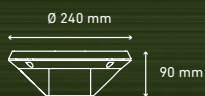

NOTA: INCLUYE ARILLOS AZUL Y BLANCO

CLAVE
L1150-0H0

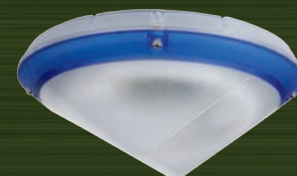

S20 FLAT



NOTA: INCLUYE ARILLOS AZUL Y BLANCO

CLAVE
L1151-0H0

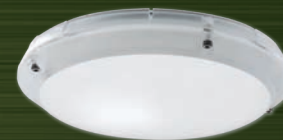

BW 300



COLOR	CLAVE
BLANCO	L1311-100
CHOCOLATE	L1311-800

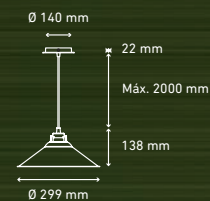

BW 350

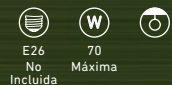

COLOR	CLAVE
BLANCO	L1312-100
CHOCOLATE	L1312-800

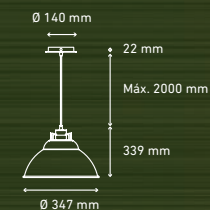

CAMPANA Z20



COLOR	ACRÍLICO	CLAVE
BLANCO	CLARO	L1302-100
GRIS ACERO	CLARO	L1302-600

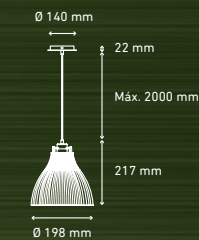



COLOR	CLAVE
BLANCO	L1401-100
NÍQUEL SATÍN	L1401-B00

GLOBE 6"

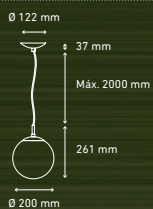

COLOR	CLAVE
BLANCO	L1402-100
NÍQUEL SATÍN	L1402-B00

GLOBE 8"

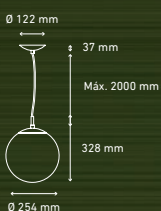

COLOR	CLAVE
BLANCO	L1403-100
NÍQUEL SATÍN	L1403-B00

GLOBE 10"

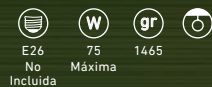
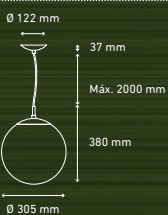

COLOR	CLAVE
BLANCO	L1404-100
NÍQUEL SATÍN	L1404-B00

GLOBE 12"

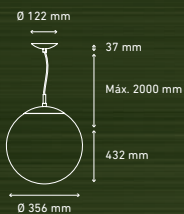

COLOR	CLAVE
BLANCO	L1405-100
NÍQUEL SATÍN	L1405-B00

GLOBE 14"

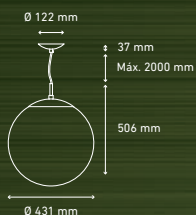

COLOR	CLAVE
BLANCO	L1406-100
NÍQUEL SATÍN	L1406-B00

GLOBE 16"



OVAL 280

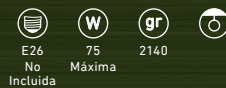

COLOR	CLAVE
BLANCO	L1410-100
NÍQUEL SATÍN	L1410-B00

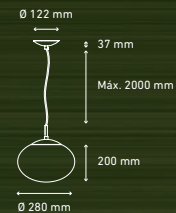

OVAL 380

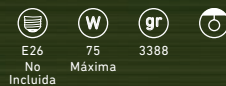

COLOR	CLAVE
BLANCO	L1411-100
NÍQUEL SATÍN	L1411-B00

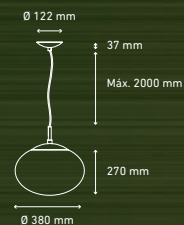

OVAL 480

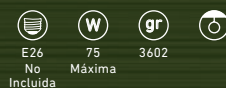

COLOR	CLAVE
BLANCO	L1412-100
NÍQUEL SATÍN	L1412-B00

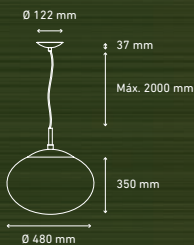

GLOBE V3

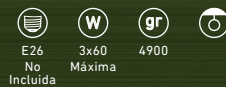

COLOR	CLAVE
BLANCO	L1421-100
NÍQUEL SATÍN	L1421-B00

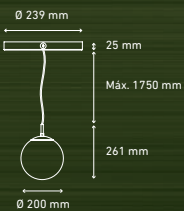

GLOBE V5

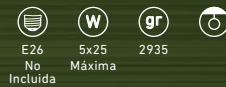

COLOR	CLAVE
BLANCO	L1420-100
NÍQUEL SATÍN	L1420-B00

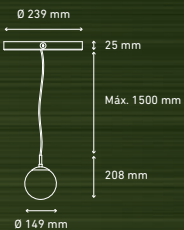

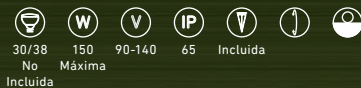
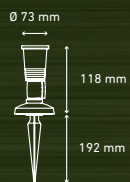

COLOR	CLAVE
NEGRO	L1501-300



BREEZE



COLOR	CLAVE
CHOCOLATE	L1503-8E0

ACCESORIOS

BASE	CLAVE
ESTACA	P0088-000



POLO

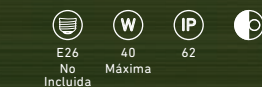
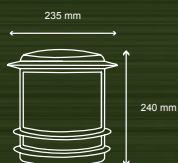

CON FOTOCELDA

COLOR	CLAVE
BLANCO	L1221-100
NÍQUEL SATÍN	L1221-800

SIN FOTOCELDA

COLOR	CLAVE
BLANCO	L1220-100
CHOCOLATE	L1220-800



FOTOCELDA



TOULOUSE

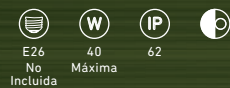
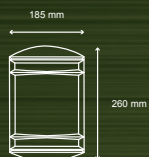

COLOR	CLAVE
BLANCO	L1230-100
CHOCOLATE	L1230-800



VERNON

OXFORD

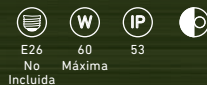
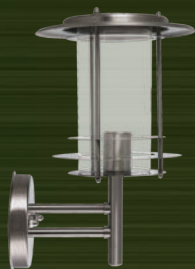

COLOR	CLAVE
ACERO INOXIDABLE	L1670-900

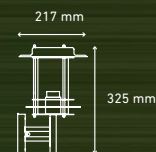

DOVER



COLOR	CLAVE
ACERO INOXIDABLE	L1671-900

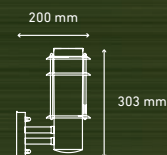

MÉRIDA



SOPORTADO

COLOR	CLAVE
BLANCO	L1601-100
NEGRO	L1601-300
CHOCOLATE	L1601-800

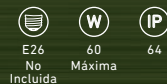

SUSPENDIDO

COLOR	CLAVE
BLANCO	L1602-100
NEGRO	L1602-300
CHOCOLATE	L1602-800

COLGANTE

COLOR	CLAVE
BLANCO	L1603-100
NEGRO	L1603-300
CHOCOLATE	L1603-800

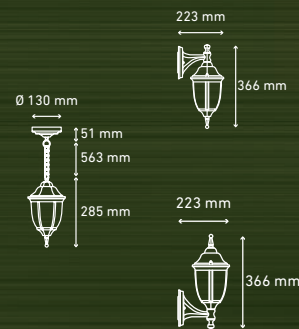

TAXCO



SOPORTADO

COLOR	CLAVE
NEGRO	L1680-300
CHOCOLATE	L1680-800

COLGANTE

COLOR	CLAVE
NEGRO	L1681-300
CHOCOLATE	L1681-800

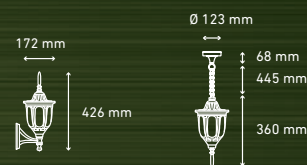

SAN MIGUEL

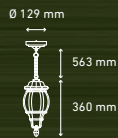
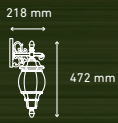

COLGANTE

COLOR	CLAVE
NEGRO	L1612-300
CHOCOLATE	L1612-800

SOPORTADO

COLOR	CLAVE
NEGRO	L1610-300
CHOCOLATE	L1610-800

SUSPENDIDO

COLOR	CLAVE
NEGRO	L1611-300
CHOCOLATE	L1611-800



COYOACÁN

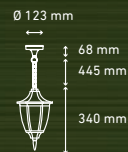

COLGANTE

COLOR	CLAVE
NEGRO	L1662-300
CHOCOLATE	L1662-800

SOPORTADO

COLOR	CLAVE
NEGRO	L1660-300
CHOCOLATE	L1660-800

SUSPENDIDO

COLOR	CLAVE
NEGRO	L1661-300
CHOCOLATE	L1661-800



QUERÉTARO

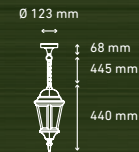
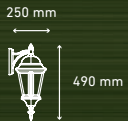

COLGANTE

COLOR	CLAVE
NEGRO	L1632-300
CHOCOLATE	L1632-800

SOPORTADO

COLOR	CLAVE
NEGRO	L1630-300
CHOCOLATE	L1630-800

SUSPENDIDO

COLOR	CLAVE
NEGRO	L1631-300
CHOCOLATE	L1631-800

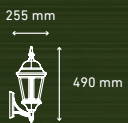

GUANAJUATO

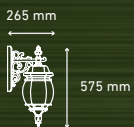

COLGANTE

COLOR	CLAVE
BLANCO	L1622-100
NEGRO	L1622-300

SOPORTADO

COLOR	CLAVE
BLANCO	L1620-100
NEGRO	L1620-300

SUSPENDIDO

COLOR	CLAVE
BLANCO	L1621-100
NEGRO	L1621-300

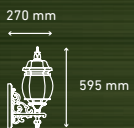





RESIDENCIAL COMERCIAL



GUÍA RÁPIDA DE LA SECCIÓN

PRODUCTO	LÁMPARA	COLOR	PAG.
EMPOTRADOS DIRIGIBLES			
	AR111	● ● ●	27
ALPHA I			
	AR111	● ● ●	27
ALPHA II			
	AR111	● ● ●	27
ALPHA III			
	AR111	● ● ●	27
ALPHA IV			
	AR111	● ● ●	27
ALPHA GAP II			
	AR111	● ● ●	28
ALPHA GAP III			
	AR111	● ● ●	29
ALPHA ROUND			
	MR16	● ● ●	30
ISIS I			
	MR16	● ● ●	30
ISIS II			
	MR16	● ● ●	30
ISIS III			
	MR16	● ● ●	30
ISIS PIN HOLE I			
	MR16	● ● ●	30
ISIS PIN HOLE II			
	MR16	● ● ●	33
SOYUZ PRO			

PRODUCTO	LÁMPARA	COLOR	PAG.
	MR16	● ● ●	33
PIN HOLE DIRIGIBLE			
	MR16	● ● ●	33
OVNI			
	MR16	● ● ●	33
LIVING			
	MR16	● ● ●	33
SOYUZ 95mm			
	MR16	● ● ●	34
SOYUZ 122mm			
	MR16	● ● ●	34
ECLIPSE			

PRODUCTO	LÁMPARA	COLOR	PAG.
EMPOTRADOS FIJOS			
	MR16	● ● ●	31
TEC 10			
	MR16	● ● ●	31
TEC 30			
	MR16	● ● ●	31
TEC 40			
	MR16	● ● ●	31
TEC 50			
	MR16	● ● ●	31
ORIÓN PRO			
	MR16	● ● ●	32
ORIÓN CIRCULAR			
	MR11	● ● ●	32
MINI ORIÓN			

PRODUCTO	LÁMPARA	COLOR	PAG.
	MR16	● ● ●	32
SATURNO			
	MR16	● ● ●	32
NIZA			
	MR16	● ● ●	32
MERCURIO PLUS			

PRODUCTO	LÁMPARA	COLOR	PAG.
SUSPENDIDOS			
	AR111	● ● ●	28
ALPHA SUSP. II			
	AR111	● ● ●	28
ALPHA SUSP. III			
	AR111	● ● ●	28
ALPHA SUSP. IV L			
	AR111	● ● ●	29
ALPHA SUSP. IV			

PRODUCTO	LÁMPARA	COLOR	PAG.
SOBREPUESTOS			
	AR111	● ● ●	29
ALPHA A RIEL			
	AR111	● ● ●	29
ALPHA A CÁNOPE			
	MR16	● ● ●	34
CILINDRO A RIEL			
	MR16	● ● ●	34
SIROCCO A RIEL			

PRODUCTO	LÁMPARA	COLOR	PAG.
	MR16	● ● ●	35
CILINDRO A CÁNOPE			
	MR16	● ● ●	35
SIROCCO A CÁNOPE			
	MR16	● ● ●	35
CILINDRO A RIEL ECONÓMICO			
	MR16	● ● ●	35
CILINDRO A CÁNOPE ECONÓMICO			
	PAR 38	● ● ●	36
SWING A RIEL PAR 38			
	PAR 38	● ● ●	37
SWING A CÁNOPE PAR 38			
	PAR 30	● ● ●	37
SWING A RIEL PAR 30			
	PAR 30	● ● ●	37
SWING A CÁNOPE PAR 30			
	MR16	● ● ●	36
KIT FIRE			

● GRIS ● CHOCOLATE ● NIQUEL SATÍN
● BLANCO ● NEGRO

ALPHA I



COLOR	CLAVE
BLANCO	L1701-1E5
NEGRO	L1701-3E5
GRIS	L1701-5E5



ALPHA II

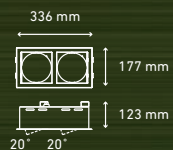

COLOR	CLAVE
BLANCO	L1702-1E5
NEGRO	L1702-3E5
GRIS	L1702-5E5



ALPHA III

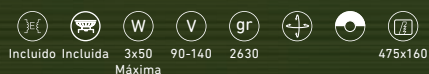
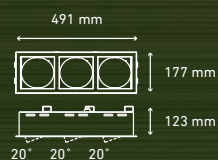

COLOR	CLAVE
BLANCO	L1703-1E5
NEGRO	L1703-3E5
GRIS	L1703-5E5



ALPHA IV

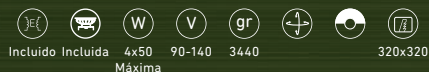
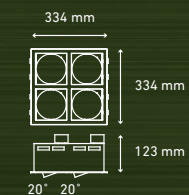

COLOR	CLAVE
BLANCO	L1704-1E5



ALPHA GAP II

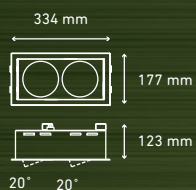

COLOR	CLAVE
BLANCO	L1710-1E5
NEGRO	L1710-3E5



ALPHA GAP III



COLOR	CLAVE
BLANCO	L1711-1E5
NEGRO	L1711-3E5

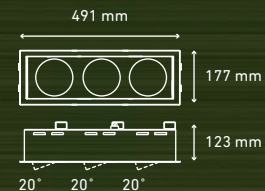

ALPHA SUSPENDIDO II



COLOR	CLAVE
BLANCO	L1720-1E5

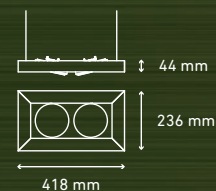

ALPHA SUSPENDIDO III



COLOR	CLAVE
BLANCO	L1721-1E5

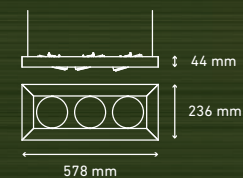

ALPHA SUSPENDIDO IV L

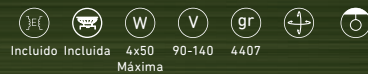

COLOR	CLAVE
BLANCO	L1723-1E5

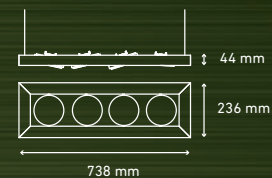

ALPHA SUSPENDIDO IV

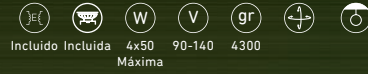
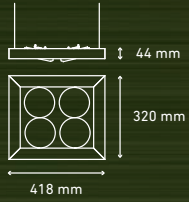

COLOR	CLAVE
BLANCO	L1722-1E5



ALPHA ROUND

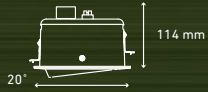

COLOR	CLAVE
BLANCO	L1730-1E5



ALPHA A RIEL

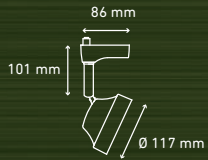

COLOR	CLAVE
BLANCO	L1731-1E5
NEGRO	L1731-3E5
CHOCOLATE	L1731-8E5



ALPHA A CÁNOPE

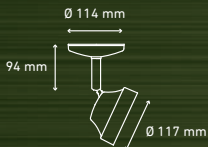

COLOR	CLAVE
BLANCO	L1732-1E5
NEGRO	L1732-3E5
CHOCOLATE	L1732-8E5



ISIS I



Incluido GU 5.3 12V
 Incluida 1x50 90-140 3000 100x100

COLOR	CLAVE
BLANCO	L1740-1E0
NEGRO	L1740-3E0
GRIS	L1740-5E0



ISIS II



Incluido GU 5.3 12V
 Incluida 2x50 90-140 3000 1130 195x100

COLOR	CLAVE
BLANCO	L1741-1E0
NEGRO	L1741-3E0
GRIS	L1741-5E0

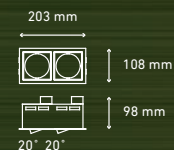

ISIS III



Incluido GU 5.3 12V
 Incluida 3x50 90-140 3000 1430 285x100

COLOR	CLAVE
BLANCO	L1742-1E0
NEGRO	L1742-3E0
GRIS	L1742-5E0

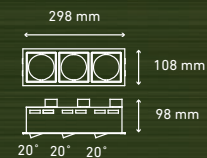

ISIS PIN HOLE I



Incluido GU 5.3 12V
 Incluida 1x50 90-140 3000 100x100

COLOR	CLAVE
BLANCO	L1743-1E0
GRIS	L1743-5E0



ISIS PIN HOLE II



Incluido GU 5.3 12V
 Incluida 2x50 90-140 3000 1035 195x100

COLOR	CLAVE
BLANCO	L1744-1E0

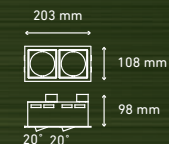

TEC 10

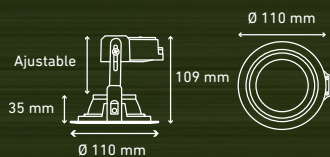

COLOR	BASE	CLAVE
BLANCO	GU 5.3	L1771-100



TEC 30

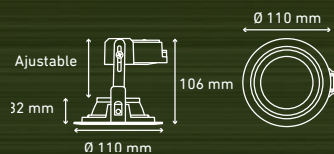

COLOR	BASE	CLAVE
BLANCO	GU 5.3	L1772-100
CHOCOLATE	GU 5.3	L1772-800

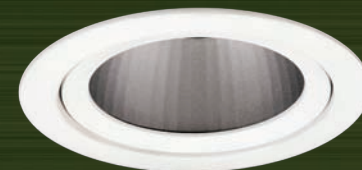

TEC 40

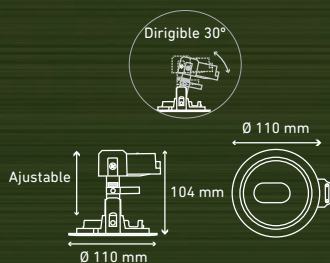

COLOR	BASE	CLAVE
BLANCO	GU 5.3	L1773-100
NÍQUEL SATÍN	GU 5.3	L1773-800



TEC 50

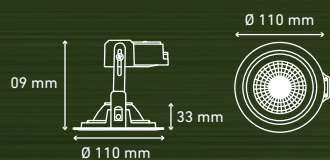

COLOR	BASE	CLAVE
BLANCO	GU 5.3	L1774-100
CHOCOLATE	GU 5.3	L1774-800
NÍQUEL SATÍN	GU 5.3	L1774-800

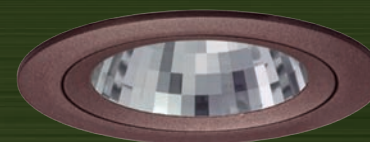

ORIÓN PRO

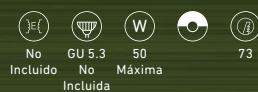

COLOR	CLAVE
BLANCO	L1750-100
CHOCOLATE	L1750-800
NÍQUEL SATÍN	L1750-800

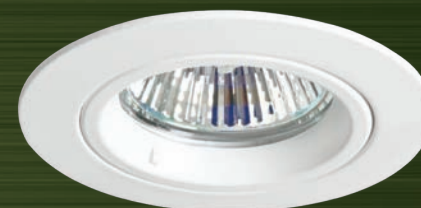

ORIÓN CIRCULAR

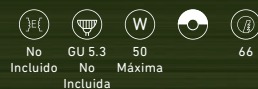

COLOR	CLAVE
BLANCO	L1751-100



MINI ORIÓN

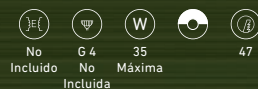
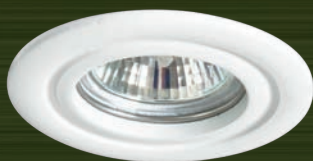

COLOR	CLAVE
BLANCO	L1755-100



SATURNO

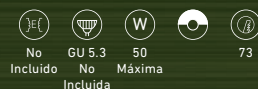

COLOR	CLAVE
BLANCO	L1782-100
CHOCOLATE	L1782-800



NIZA

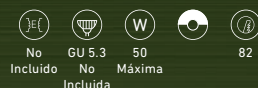

COLOR	CLAVE
BLANCO	L1753-100



MERCURIO PLUS

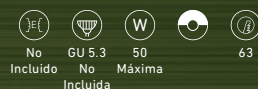

COLOR	CLAVE
BLANCO	L1754-100
CHOCOLATE	L1754-800
NÍQUEL SATÍN	L1754-B00

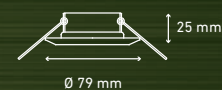

SOYUZ PRO

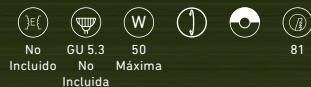
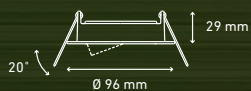

COLOR	CLAVE
BLANCO	L1760-100
CHOCOLATE	L1760-800
NÍQUEL SATÍN	L1760-B00



PIN HOLE DIRIGIBLE

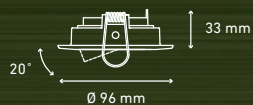

COLOR	CLAVE
BLANCO / NEGRO	L1761-300
BLANCO / BLANCO	L1761-100

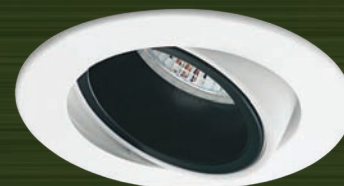

OVNI

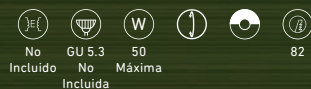
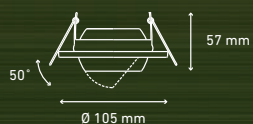

COLOR	CLAVE
BLANCO	L1762-100



LIVING

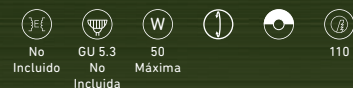
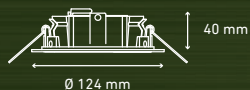

COLOR	CLAVE
BLANCO	L1766-100

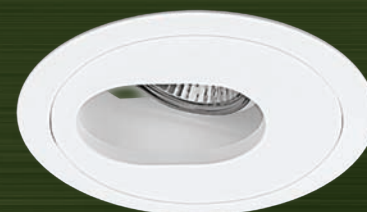

SOYUZ Ø 95mm

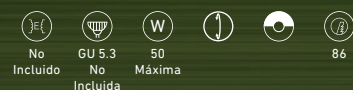

COLOR	CLAVE
BLANCO	L1764-100
CHOCOLATE	L1764-800
NÍQUEL SATÍN	L1764-B00



SOYUZ Ø 122mm

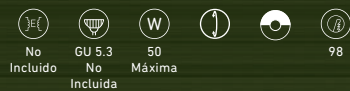

COLOR	CLAVE
BLANCO	L1765-100

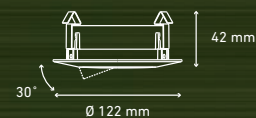

ECLIPSE

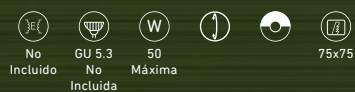

COLOR	CLAVE
BLANCO	L1767-100

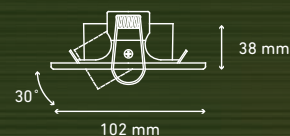

CILINDRO A RIEL



COLOR	CLAVE
BLANCO	L1801-1E0
NEGRO	L1801-3E0
CHOCOLATE	L1801-8E0

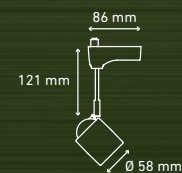

SIROCCO A RIEL



COLOR	CLAVE
BLANCO	L1802-1E0

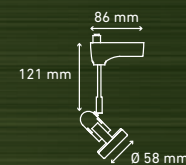

CILINDRO A CÁNOPE

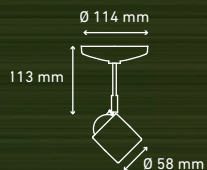

COLOR	CLAVE
BLANCO	L1810-1E0
NEGRO	L1810-3E0
CHOCOLATE	L1810-8E0



SIROCCO A CÁNOPE

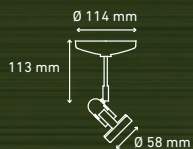

COLOR	CLAVE
BLANCO	L1811-1E0



CILINDRO A RIEL ECONÓMICO

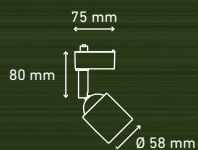

COLOR	CLAVE
BLANCO	L1820-100
NEGRO	L1820-300



CILINDRO A CÁNOPE ECONÓMICO

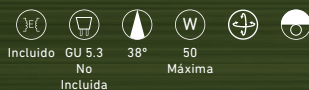
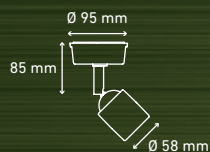

COLOR	CLAVE
BLANCO	L1821-100
NEGRO	L1821-300



KIT FIRE

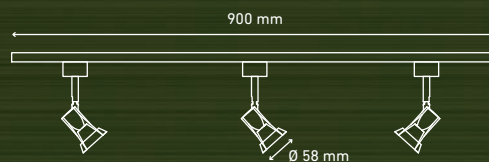

GU 10
Incluida

W

3x50

V

90-140

K

2700

gr

1060

↔

☉

COLOR	CLAVE
-------	-------

BLANCO	L1850-110
--------	-----------

SWING A RIEL PAR 38



Par 38
No
Incluida

W

150

Máxima

COLOR	CLAVE
-------	-------

BLANCO	L1832-100
--------	-----------

NEGRO	L1832-300
-------	-----------

CHOCOLATE	L1832-800
-----------	-----------

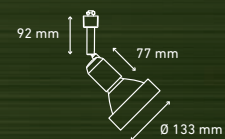

SWING A RIEL PAR 30

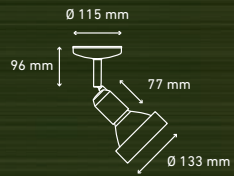

COLOR	CLAVE
BLANCO	L1842-100
NEGRO	L1842-300
CHOCOLATE	L1842-800



SWING A CÁNOPE PAR 38

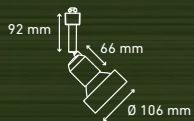

COLOR	CLAVE
BLANCO	L1833-100
NEGRO	L1833-300
CHOCOLATE	L1833-800



SWING A CÁNOPE PAR 30

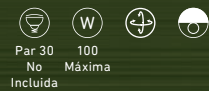
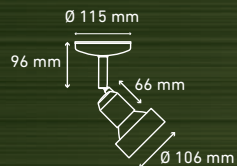





COLOR	CLAVE
BLANCO	L1843-100
NEGRO	L1843-300
CHOCOLATE	L1843-800



GUÍA RÁPIDA DE LA SECCIÓN

PRODUCTO	K	LÁMPARA	BASE	PAG.
13W ELECTROMAGNÉTICO				
	4100 K	LFC 2U	GX 23-2	39
SHOT II CENTER 175 mm				
13W ELECTRÓNICO				
	4100 K	LFC E	GU 21	39
SHOT EXTRA MINI AL OPEN 175mm				
	2700 K 4100 K 6500 K	LFC E	GU 21	39
SHOT EXTRA MINI CENTER 175 mm				
	2700 K 4100 K 6500 K	LFC E	GU 21	39
SHOT EXTRA MINI FROSTED 175 mm				
	2700 K 4100 K 6500 K	LFC E	GU 21	40
SHOT EXTRA MINI CENTER 158 mm				
	2700 K 4100 K	LFC E	GU 21	41
SHOT EXTRA MINI CENTER WOOD 175mm				
	2700 K 4100 K 6500 K	LFC E	GU 21	42
SHOT EXTRA MINI SUSPENDIDO 175mm				
13W ELECTRÓNICO STEEL				
	4100 K	LFC E	GU 21	40
SHOT EXTRA MINI CENTER NIQUEL SATIN 158 mm				
	2700 K 4100 K 6500 K	LFC E	GU 21	40
SHOT EXTRA MINI CENTER BRASS 158 mm				
	4100 K 6500 K	LFC E	GU 21	40
SHOT EXTRA MINI CENTER CROMO 158 mm				

PRODUCTO	K	LÁMPARA	BASE	PAG.
	2700 K 4100 K	LFC E	GU 21	41
SHOT EXTRA MINI FROSTED NIQUEL SATIN 158 mm				
	4100 K	LFC E	GU 21	41
SHOT EXTRA MINI OPEN 158 mm				
13W AUTOBALASTRADO				
	2700 K 6500 K	LFC AB FE	E26	42
SHOT II E26 AL OPEN 175mm				
	2700 K 6500 K	LFC AB FE	E26	42
SHOT II E26 CENTER 175mm				
	6500 K	LFC AB FE	E26	42
SHOT II E26 AL OPEN 158mm				
	2700 K 6500 K	LFC AB FE	E26	43
SHOT II E26 CENTER 158 mm				
	2700 K 6500 K	LFC AB FE	E26	43
SHOT II E26 CENTER STEEL 158 mm				
	2700 K 6500 K	LFC AB FE	E26	43
SHOT II E26 SUSPENDIDO				
2X13W ELECTROMAGNÉTICO				
	4100 K	LFC U	GX 23	43
FIT II OPEN				
	2700 K 4100 K	LFC U	GX 23	44
FIT II CENTER				
	4100 K	LFC U	GX 23	44
FIT II FROSTED				

PRODUCTO	K	LÁMPARA	BASE	PAG.
	2700 K 4100 K	LFC U	GX 23	44
FIT CENTER NIQUEL SATIN				
2X13 ELECTRÓNICO				
	4100 K	LFC 2U	G24 q-1	44
FIT II OPEN				
	2700 K 4100 K	LFC 2U	G24 q-1	45
FIT II CENTER				
	4100 K	LFC 2U	G24 q-1	45
FIT CENTER NIQUEL SATIN				
2X14W AUTOBALASTRADO				
	4100 K	LFC AB 3U	E26	45
FIT OPEN				
	2700 K 4100 K 6500 K	LFC AB 3U	E26	45
FIT CENTER				
	2700 K 4100 K	LFC AB 3U	E26	46
FIT CENTER NIQUEL SATIN				
	4100 K	LFC AB 3U	E26	46
FIT BAFLE				
	2700 K 4100 K 6500 K	LFC AB 3U	E26	47
SQUARE				
2X26W ELECTRÓNICO				
	4100 K	LFC 2U	G24 q-3	46
FIT OPEN				
	2700 K 4100 K	LFC 2U	G24 q-3	46
FIT CENTER				
2X26W AUTOBALASTRADO				
	2700 K 4100 K 6500 K	LFC AB 3U	E26	47
SQUARE 2x26				

SHOT II CENTER Ø 175 mm

13W ELECTROMAGNÉTICO

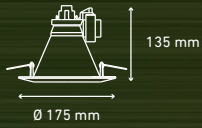

COLOR	K	CLAVE
BLANCO	4100	L1902-1F0

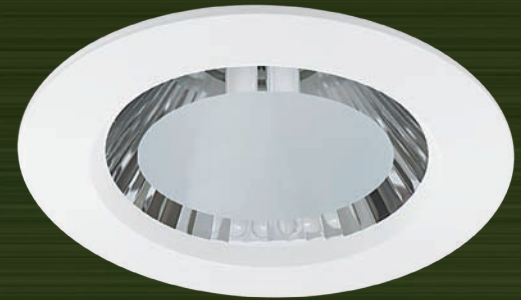

SHOT EXTRA MINI AL OPEN Ø 175 mm

13W ELECTRÓNICO

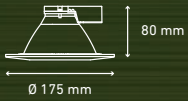

COLOR	K	CLAVE
BLANCO	4100	L1910-1F0

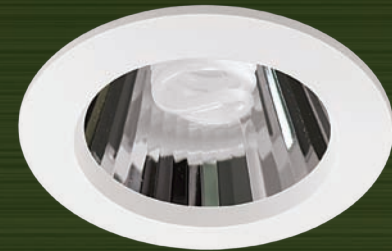

SHOT EXTRA MINI CENTER Ø 175 mm

13W ELECTRÓNICO

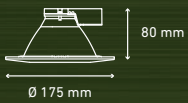

COLOR	K	CLAVE
BLANCO	2700	L1911-110
BLANCO	4100	L1911-1F0
BLANCO	6500	L1911-1G0
NEGRO	4100	L1911-3F0
NEGRO	6500	L1911-3G0

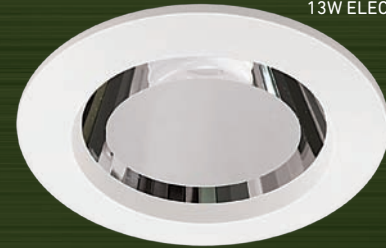

SHOT EXTRA MINI FROSTED Ø 175 mm

13W ELECTRÓNICO

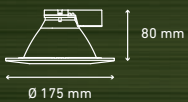

COLOR	K	CLAVE
BLANCO	2700	L1912-110
BLANCO	4100	L1912-1F0
BLANCO	6500	L1912-1G0



SHOT EXTRA MINI CENTER Ø 158 mm

13W ELECTRÓNICO



COLOR	K	CLAVE
BLANCO	2700	L1916-110
BLANCO	4100	L1916-1F0
BLANCO	6500	L1916-1G0
NEGRO	4100	L1916-3F0

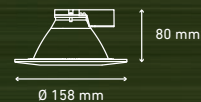

SHOT EXTRA MINI CENTER NÍQUEL SATÍN Ø 158 mm

13W ELECTRÓNICO STEEL

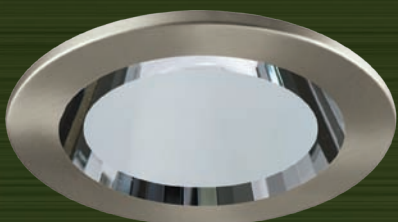

COLOR	K	CLAVE
NÍQUEL SATÍN	2700	L1917-B10
NÍQUEL SATÍN	4100	L1917-BF0
NÍQUEL SATÍN	6500	L1917-BG0

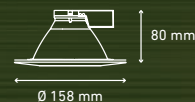

SHOT EXTRA MINI CENTER BRASS Ø 158 mm

13W ELECTRÓNICO STEEL

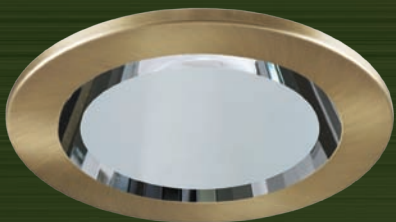

COLOR	K	CLAVE
BRASS	2700	L1917-D10
BRASS	4100	L1917-DF0
BRASS	6500	L1917-DG0



SHOT EXTRA MINI CENTER CROMO Ø 158 mm

13W ELECTRÓNICO STEEL

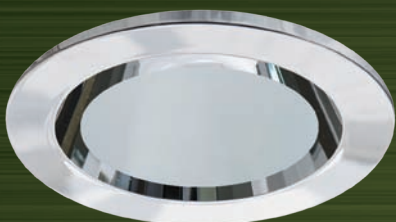

COLOR	K	CLAVE
CROMO	4100	L1917-CF0
CROMO	6500	L1917-CG0

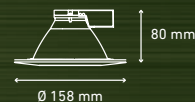

SHOT EXTRA MINI FROSTED NÍQUEL SATÍN Ø 158 mm

13W ELECTRÓNICO STEEL

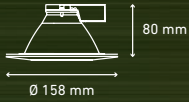

COLOR	K	CLAVE
NÍQUEL SATÍN	2700	L1918-B10
NÍQUEL SATÍN	4100	L1918-BF0

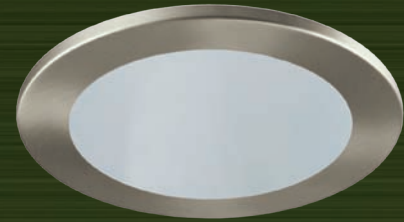

SHOT EXTRA MINI OPEN Ø 158 mm

13W ELECTRÓNICO STEEL



COLOR	K	CLAVE
NÍQUEL SATÍN	4100	L1919-BF0

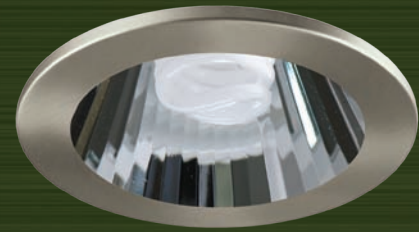

SHOT EXTRA MINI CENTER WOOD Ø 175 mm

13W ELECTRÓNICO

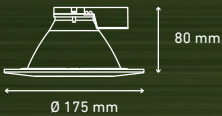

COLOR	K	CLAVE
CEREZO	2700	L1914-F10
CEREZO	4100	L1914-FF0
CAOBA	2700	L1914-G10
CAOBA	4100	L1914-GF0

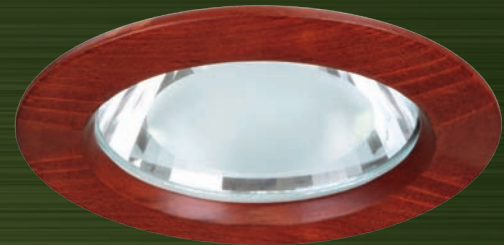

SHOT EXTRA MINI SUSPENDIDO Ø 175 mm

13W ELECTRÓNICO

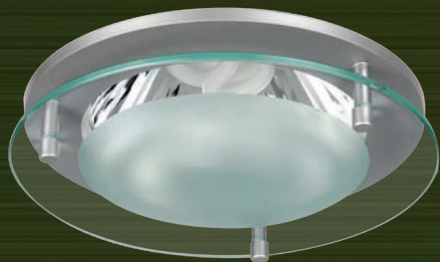

COLOR	K	CLAVE
BLANCO	2700	L1915-110
BLANCO	4100	L1915-1F0
BLANCO	6500	L1915-1G0
NÍQUEL SATÍN	4100	L1915-BF0
NÍQUEL SATÍN	6500	L1915-BG0

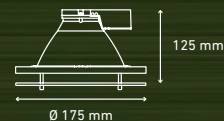

SHOT II E26 AL OPEN Ø 175 mm

13W AUTOBALASTRADO

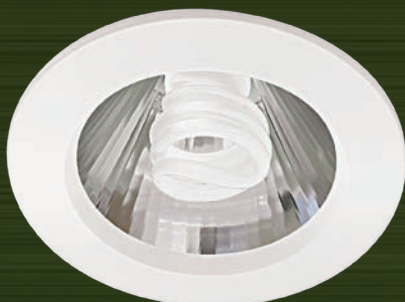

COLOR	K	CLAVE
BLANCO	2700	L1920-110
BLANCO	6500	L1920-1G0

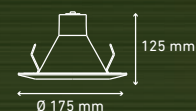

SHOT II E26 CENTER Ø 175 mm

13W AUTOBALASTRADO



COLOR	K	CLAVE
BLANCO	2700	L1921-110
BLANCO	6500	L1921-1G0
NEGRO	6500	L1921-3G0

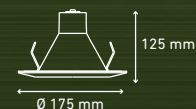

SHOT II E26 AL OPEN Ø 158 mm

13W AUTOBALASTRADO

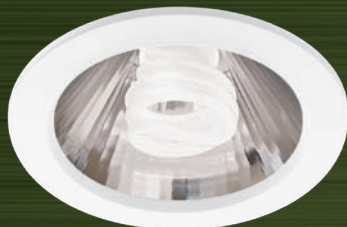

COLOR	K	CLAVE
BLANCO	6500	L1923-1G0

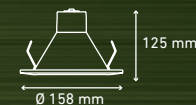

SHOT II E26 CENTER Ø 158 mm
13W AUTOBALASTRADO

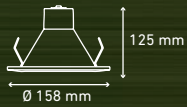

COLOR	K	CLAVE
BLANCO	2700	L1924-110
BLANCO	6500	L1924-1G0



SHOT II E26 CENTER STEEL Ø 158 mm
13W AUTOBALASTRADO

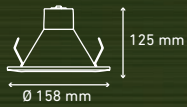

COLOR	K	CLAVE
CROMO	6500	L1925-CG0
NÍQUEL SATÍN	2700	L1925-B10
NÍQUEL SATÍN	6500	L1925-BG0



SHOT II E26 SUSPENDIDO
13W AUTOBALASTRADO

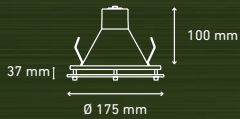

COLOR	K	CLAVE
BLANCO	2700	L1922-110
BLANCO	6500	L1922-1G0
NÍQUEL SATÍN	2700	L1922-B10
NÍQUEL SATÍN	6500	L1922-BG0

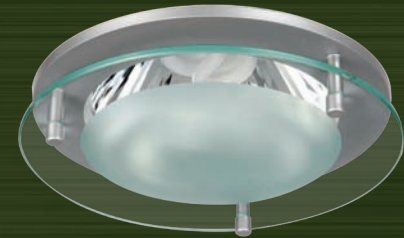

FIT II OPEN
2x13W ELECTROMAGNÉTICO

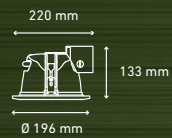

COLOR	K	CLAVE
BLANCO	4100	L1930-1F0



FIT II CENTER

2x13W ELECTROMAGNÉTICO



COLOR	K	CLAVE
BLANCO	2700	L1931-110
BLANCO	4100	L1931-1F0

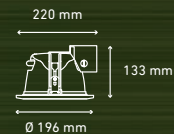

FIT II FROSTED

2x13W ELECTROMAGNÉTICO

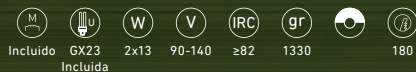

COLOR	K	CLAVE
BLANCO	4100	L1932-1F0

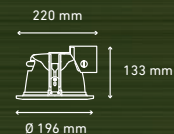

FIT CENTER NÍQUEL SATÍN

2x13W ELECTROMAGNÉTICO

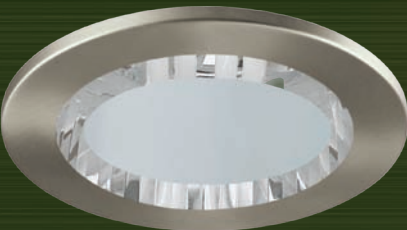

COLOR	K	CLAVE
NÍQUEL SATÍN	2700	L1933-B10
NÍQUEL SATÍN	4100	L1933-BF0

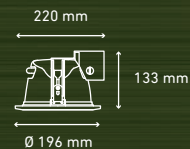

FIT II OPEN

2x13W ELECTRÓNICO

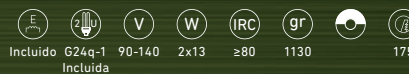

COLOR	K	CLAVE
BLANCO	4100	L1934-1F0

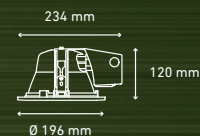

FIT II CENTER

2x13W ELECTRÓNICO

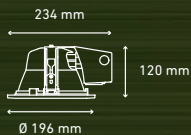

COLOR	K	CLAVE
BLANCO	2700	L1935-110
BLANCO	4100	L1935-1F0

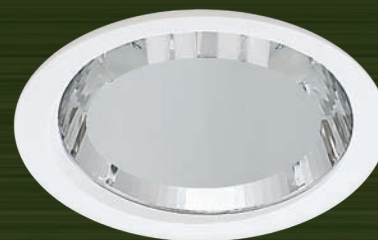

FIT CENTER NÍQUEL SATÍN

2x13W ELECTRÓNICO

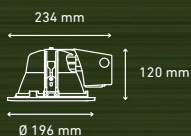

COLOR	K	CLAVE
NÍQUEL SATÍN	4100	L1936-BF0



FIT OPEN

2x14W AUTOBALASTRADO

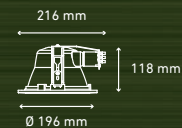

COLOR	K	CLAVE
BLANCO	4100	L1950-1F0



FIT CENTER

2x14W AUTOBALASTRADO

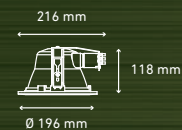

COLOR	K	CLAVE
BLANCO	2700	L1951-110
BLANCO	4100	L1951-1F0
BLANCO	6500	L1951-1G0



FIT CENTER NÍQUEL SATÍN

2x14W AUTOBALASTRADO

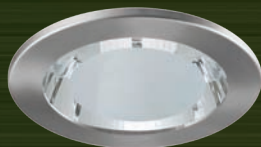

COLOR	K	CLAVE
NÍQUEL SATÍN	2700	L1952-B10
NÍQUEL SATÍN	4100	L1952-BF0

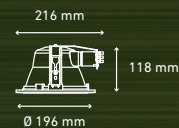

FIT BAFLE

2x14W AUTOBALASTRADO



COLOR	K	CLAVE
BLANCO	4100	L1953-1F0

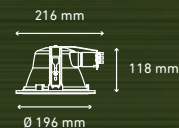

FIT OPEN

2x26W ELECTRÓNICO



COLOR	V	K	CLAVE
BLANCO	127	4100	L1943-1F0
BLANCO	100-305	4100	L1944-1F0

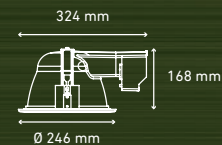

FIT CENTER

2x26W ELECTRÓNICO



COLOR	V	K	CLAVE
BLANCO	127	2700	L1945-110
BLANCO	127	4100	L1945-1F0
BLANCO	100-305	4100	L1946-1F0

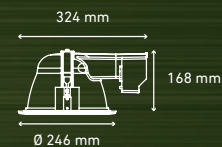

FIT OPEN

2x26W AUTOBALASTRADO

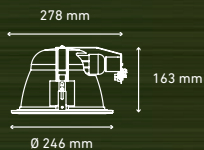

COLOR	K	CLAVE
BLANCO	4100	L1947-1F0
BLANCO	6500	L1947-1G0



FIT CENTER

2x26W AUTOBALASTRADO

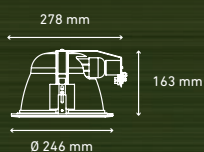

COLOR	K	CLAVE
BLANCO	2700	L1948-110
BLANCO	4100	L1948-1F0
BLANCO	6500	L1948-1G0



SQUARE 2x14W

2x14W AUTOBALASTRADO

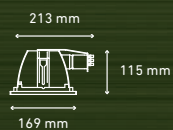

COLOR	K	CLAVE
BLANCO	2700	L1980-110
BLANCO	4100	L1980-1F0
BLANCO	6500	L1980-1G0

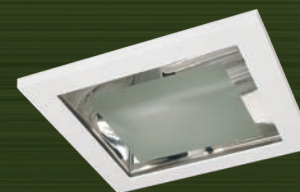

SQUARE 2x26W

2x26W AUTOBALASTRADO

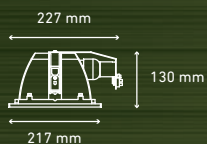

COLOR	K	CLAVE
BLANCO	2700	L1981-110
BLANCO	4100	L1981-1F0
BLANCO	6500	L1981-1G0



GUÍA RÁPIDA DE LA SECCIÓN



PRODUCTO LÁMPARA PAG.

SUSPENDIDOS

	E26	49
MILL E26		
	E26	49
E26		
	E26	49
F65		
	E26	49
LIVER		
	T5	57
SKY BOLD 1X54, 1X80, 2X1X54		
	T5	58
SKY DIRECTA 1X54 T5		
	T5	58
SKY INDIRECTA 1X54 T5		
	T5	58
SKY LOUVER 1X54 T5		
	T5	58
SKY INDIRECTO 2X1X54 T5		
	T5	57
SLIM DIRECTA / INDIRECTA 2X28W T5, 2X54W		

PRODUCTO LÁMPARA PAG.

SOBREPUESTOS

	T8	50
TRACK 2X32W T8		
	T8	50
TRACK WAVE 2X32W T8		
	T8	50
GÉMINIS		
	T5	51
BLOCK 2X14W T5, 2X21W, 2X28W, 2X35W		
	T5	52
STICK 1X14W T5, 1X21W, 1X28W, 1X35W		
	T5	54
CLIPPER 8, 24, 39, 54		
	T5	55
ICE 2X24W		
	T5	55
ICE 4X24W		
	T5	55
ICE 2X54W		
	T5	56
ICE 3X54W		

PRODUCTO LÁMPARA PAG.

	T5	56
WIND 2X24W		
	T5	56
WIND 4X24W		
	T5	59
BL 24, 39, 54, 80, 32		
	T5	60
BL C 32		
	T5	61
BL PLUS 28, 54, 80		

SOBREPONER A MURO

FIT CENTER		
	E26	62
STREET F 45W		
	E40	62
STREET F 65W		
	E40	63
GUARDIAN		
	E26	63
GOLD		
	E26	63
KITE		

MILL E26



COLOR	ACRÍLICO	CLAVE
BLANCO	FROSTED	L2003-100
BLANCO	CLEAR	L2004-100
CHOCOLATE	CLEAR	L2004-800



E26

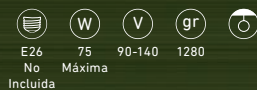
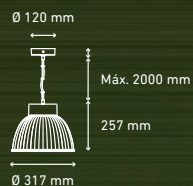

COLOR	ACRÍLICO	CLAVE
BLANCO	FROSTED	L2005-100
BLANCO	CLEAR	L2006-100
CHOCOLATE	CLEAR	L2006-800



F65

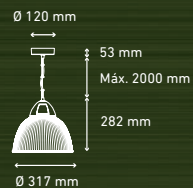

ACRÍLICO	CLAVE
ICE	L2002-IG0
ICE CLEAR	L2008-IG0



LIVER

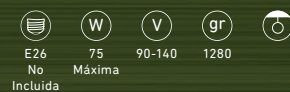

COLOR	ACRÍLICO	CLAVE
CHOCOLATE	CLEAR	L2001-800
NÍQUEL SATÍN	FROSTED	L2007-B00



TRACK 2x32W T8



COLOR	K	CLAVE
BLANCO	4100	L2104-1F0
BLANCO	6500	L2104-1G0



TRACK WAVE 2x32W T8



COLOR	K	CLAVE
BLANCO	4100	L2105-1F0
BLANCO	6500	L2105-1G0



GÉMINIS 2x32W T8



COLOR	K	CLAVE
BLANCO	4100	L2106-1F0
BLANCO	6500	L2106-1G0



BLOCK 2x14W T5







 Incluido G5 2x14 90-140 ≥82



COLOR	K	CLAVE
BLANCO	4100	L2110-1F0
BLANCO	6500	L2110-1G0



BLOCK 2x21W T5







 Incluido G5 2x21 90-140 ≥82 1409



COLOR	K	CLAVE
BLANCO	4100	L2111-1F0
BLANCO	6500	L2111-1G0

BLOCK 2x28W T5







 Incluido G5 2x28 90-140 ≥82 1650



COLOR	K	CLAVE
BLANCO	4100	L2112-1F0
BLANCO	6500	L2112-1G0

BLOCK 2x35W T5









 Incluido G5 2x35 90-140 ≥82 2070

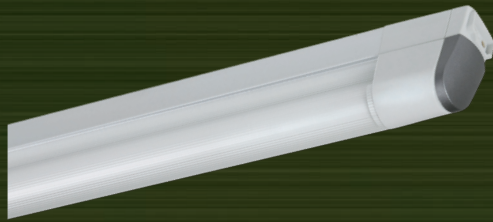

COLOR	K	CLAVE
BLANCO	4100	L2113-1F0
BLANCO	6500	L2113-1G0

STICK 1x14W T5



SISTEMA DE INTERCONEXIÓN

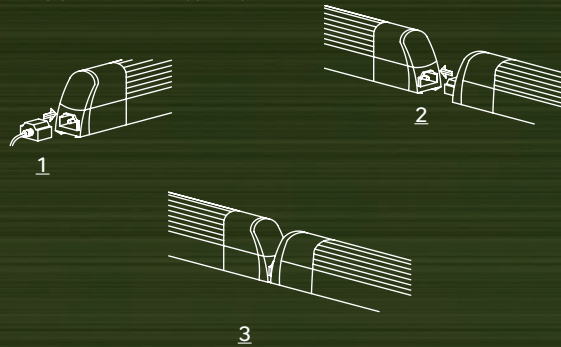

NOTA: INTERCONEXIÓN MÁXIMA: 12

COLOR	K	CLAVE
BLANCO	4100	L2120-1F0
BLANCO	6500	L2120-1G0

STICK 1x21W T5

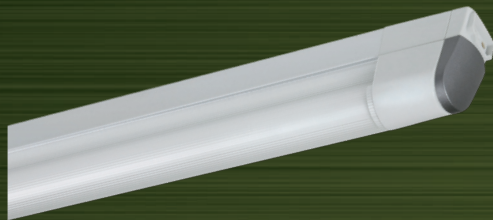

NOTA: INTERCONEXIÓN MÁXIMA: 8

COLOR	K	CLAVE
BLANCO	4100	L2121-1F0
BLANCO	6500	L2121-1G0

STICK 1x28W T5

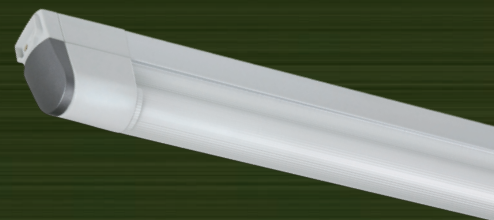

1205 mm

NOTA: INTERCONEXIÓN MÁXIMA: 6

COLOR	K	CLAVE
BLANCO	3500	L2122-1J0
BLANCO	4100	L2122-1F0
BLANCO	6500	L2122-1G0

STICK 1x35W T5

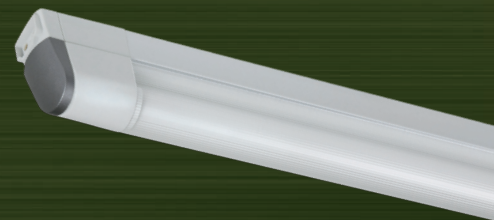

1505 mm

NOTA: INTERCONEXIÓN MÁXIMA: 5

COLOR	K	CLAVE
BLANCO	3500	L2123-1J0
BLANCO	4100	L2123-1F0
BLANCO	6500	L2123-1G0

CLIPPER 8



COLOR	K	CLAVE
ANODIZADO AL.	4100	L2130-EF0



CLIPPER 24



COLOR	K	CLAVE
ANODIZADO AL.	4100	L2131-EF0

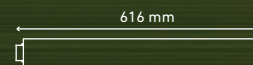

CLIPPER 39



COLOR	K	CLAVE
ANODIZADO AL.	4100	L2132-EF0



CLIPPER 54



COLOR	K	CLAVE
ANODIZADO AL.	4100	L2133-EF0
ANODIZADO AL.	6500	L2133-EG0

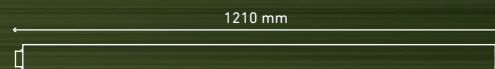

ICE 2x24W









 Includo G5 2x24 90-140 ≥82 0.5 2600



K	CLAVE
4100	L2140-5F0
6500	L2140-5G0



ICE 4x24W











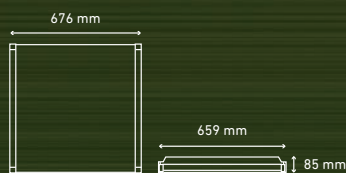

 Includo G5 4x24 90-140 ≥82 0.5 4460

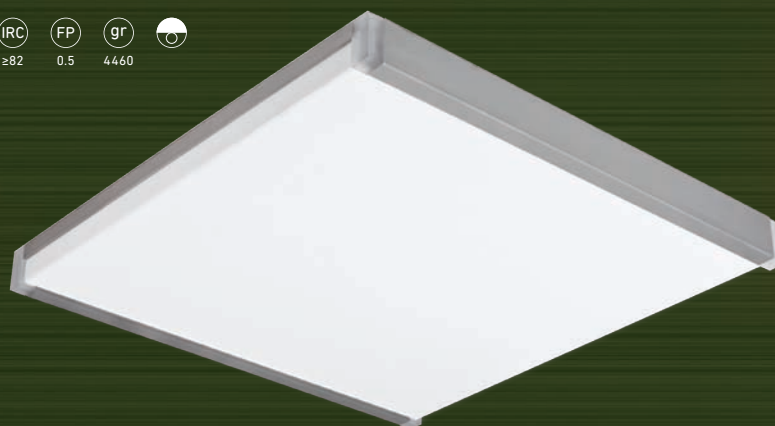



K	CLAVE
4100	L2145-5F0
6500	L2145-5G0



ICE 2x54W

 Includo G5 2x54 100-305 ≥82 0.9 4564



K	CLAVE
4100	L2142-5F0
6500	L2143-5G0



ICE 3x54W



K	CLAVE
4100	L2144-5F0
6500	L2144-5G0

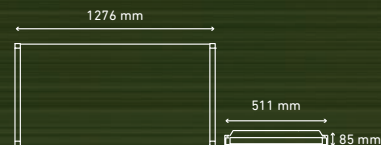

WIND 2x24W



K	CLAVE
4100	L2150-5F0
6500	L2150-5G0

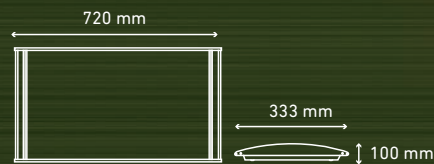

WIND 4x24W

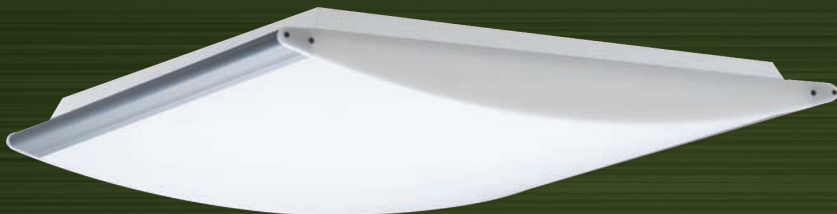

K	CLAVE
6500	L2151-5G0

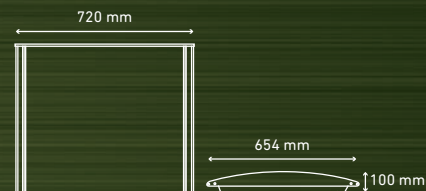

SLIM DIRECTA / INDIRECTA 2x28W T5



COLOR	CLAVE
BLANCO	L2160-1F0
GRIS	L2160-5F0

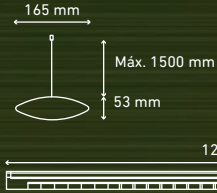

SLIM DIRECTA / INDIRECTA 2x54W T5



COLOR	CLAVE
BLANCO	L2162-1F0



SKY BOLD 1x54

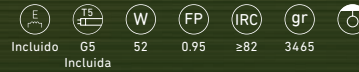

COLOR	K	V	CLAVE
BLANCO	4100	90-140	L2170-1F0
BLANCO	6500	90-140	L2170-1G0

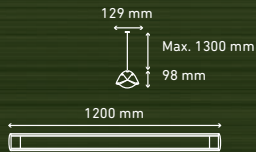

SKY BOLD 1x80

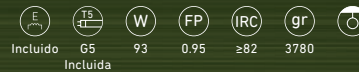

COLOR	K	V	CLAVE
BLANCO	4100	100-305	L2171-1F0
BLANCO	6500	100-305	L2171-1G0

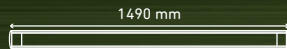

SKY BOLD 2x1x54



COLOR	K	V	CLAVE
BLANCO	4100	100-305	L2172-1F0
BLANCO	6500	100-305	L2172-1G0

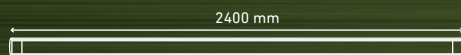

SKY DIRECTA 1x54 T5



COLOR	K	CLAVE
BLANCO	4100	L2176-1F0
GRIS	4100	L2176-5F0

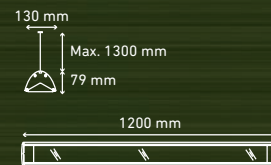

SKY INDIRECTA 1x54 T5



COLOR	K	CLAVE
BLANCO	4100	L2175-1F0



SKY LOUVER 1x54 T5



COLOR	K	CLAVE
BLANCO	4100	L2177-1F0
BLANCO	6500	L2177-1G0

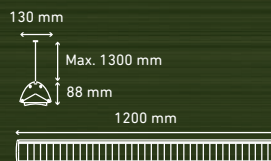

SKY INDIRECTO 2x1x54 T5



COLOR	K	CLAVE
BLANCO	4100	L2178-1F0





COLOR	K	V	CLAVE
BLANCO	4100	90-140	L2180-1F0
BLANCO	6500	90-140	L2180-1G0



* OPCIONAL BL 14W 4100K



COLOR	K	V	CLAVE
BLANCO	4100	90-140	L2181-1F0
BLANCO	6500	90-140	L2181-1G0



* OPCIONAL BL 21W 4100K



COLOR	K	V	CLAVE
BLANCO	4100	90-140	L2182-1F0
BLANCO	6500	90-140	L2182-1G0
BLANCO	4100	100-305	L2183-1F0
BLANCO	6500	100-305	L2183-1G0



* OPCIONAL BL 28W 4100K

BL 80



COLOR	K	V	CLAVE
BLANCO	4100	100-305	L2184-1F0
BLANCO	6500	100-305	L2184-1G0



* OPCIONAL BL 28W 4100K

BL 32

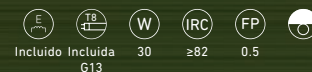

COLOR	K	V	CLAVE
BLANCO	4100	90-140	L2185-1F0
BLANCO	6500	90-140	L2185-1G0
BLANCO	4100	100-305	L2186-1F0



* OPCIONAL BL 35W 4100K

BL C 32

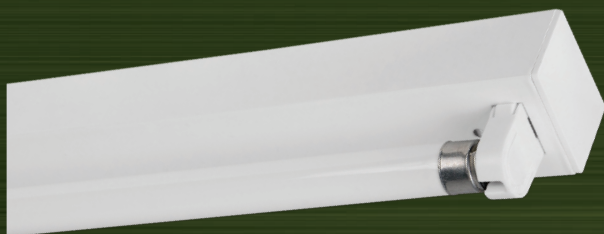

SISTEMA DE INTERCONEXIÓN



TABLA DE CONEXIÓN DE LUMINARIAS EN SERIE

	127 V~		220 V~		277 V~	
	NÚMERO DE LUMINARIAS	LONGITUD	NÚMERO DE LUMINARIAS	LONGITUD	NÚMERO DE LUMINARIAS	LONGITUD
29W T8	21	26m	27	33m	31	38m
59W T5	17	20m	22	26m	24	28m
93W T5	13	19m	16	24m	18	27m

COLOR	K	CLAVE
BLANCO	4100	L2192-1F0
BLANCO	6500	L2192-1G0

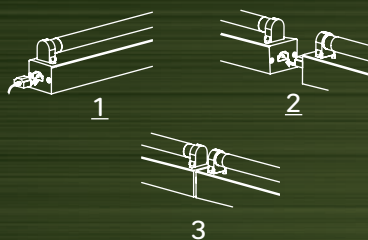
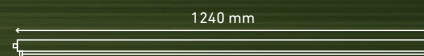

BL PLUS 28

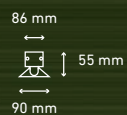
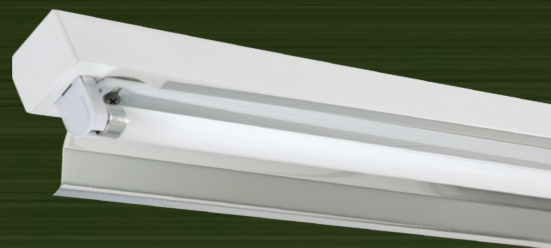

COLOR	K	CLAVE
BLANCO	4100	L2195-1F0
BLANCO	6500	L2195-1G0



BL PLUS 54



COLOR	K	CLAVE
BLANCO	4100	L2193-1F0
BLANCO	6500	L2193-1G0

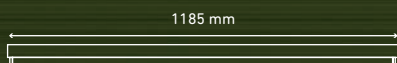

BL PLUS 80



COLOR	K	CLAVE
BLANCO	4100	L2194-1F0
BLANCO	6500	L2194-1G0

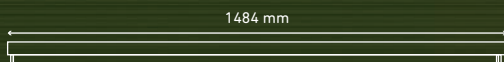

BL C 54



COLOR	K	CLAVE
BLANCO	4100	L2190-1F0
BLANCO	6500	L2190-1G0



BL C 80



COLOR	K	CLAVE
BLANCO	4100	L2191-1F0
BLANCO	6500	L2191-1G0



STREET F 45W



COLOR CLAVE
GRIS ACERO L2201-660



STREET F 65W



COLOR CLAVE
GRIS ACERO L2202-660

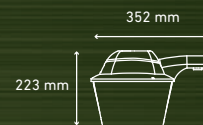

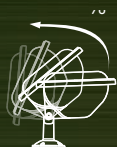

E₂₆ E40 W V K IP IRC gr ☾
 Includido E40 59 90-140 6500 65 ≥80 1200
 Includida

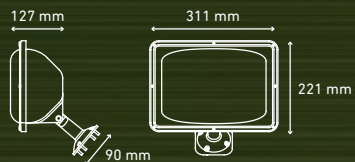

COLOR	CLAVE
GRIS ACERO	L2204-6G0



E26 W V K IRC IP ☾
 Includida E26 12 90-140 6500 ≥80 65

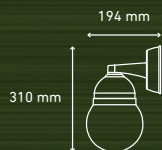

CON FOTOCELDA

COLOR	CLAVE
BLANCO	L2213-1G0

SIN FOTOCELDA

COLOR	CLAVE
BLANCO	L2212-1G0
NEGRO	L2212-3G0



E26 W V K IRC IP ☾
 Includida E26 11 90-140 6500 ≥80 65

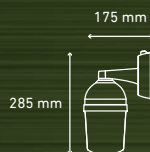

CON FOTOCELDA

COLOR	CLAVE
BLANCO	L2211-1G0
NEGRO	L2211-3G0

SIN FOTOCELDA

COLOR	CLAVE
BLANCO	L2210-1G0
NEGRO	L2210-3G0



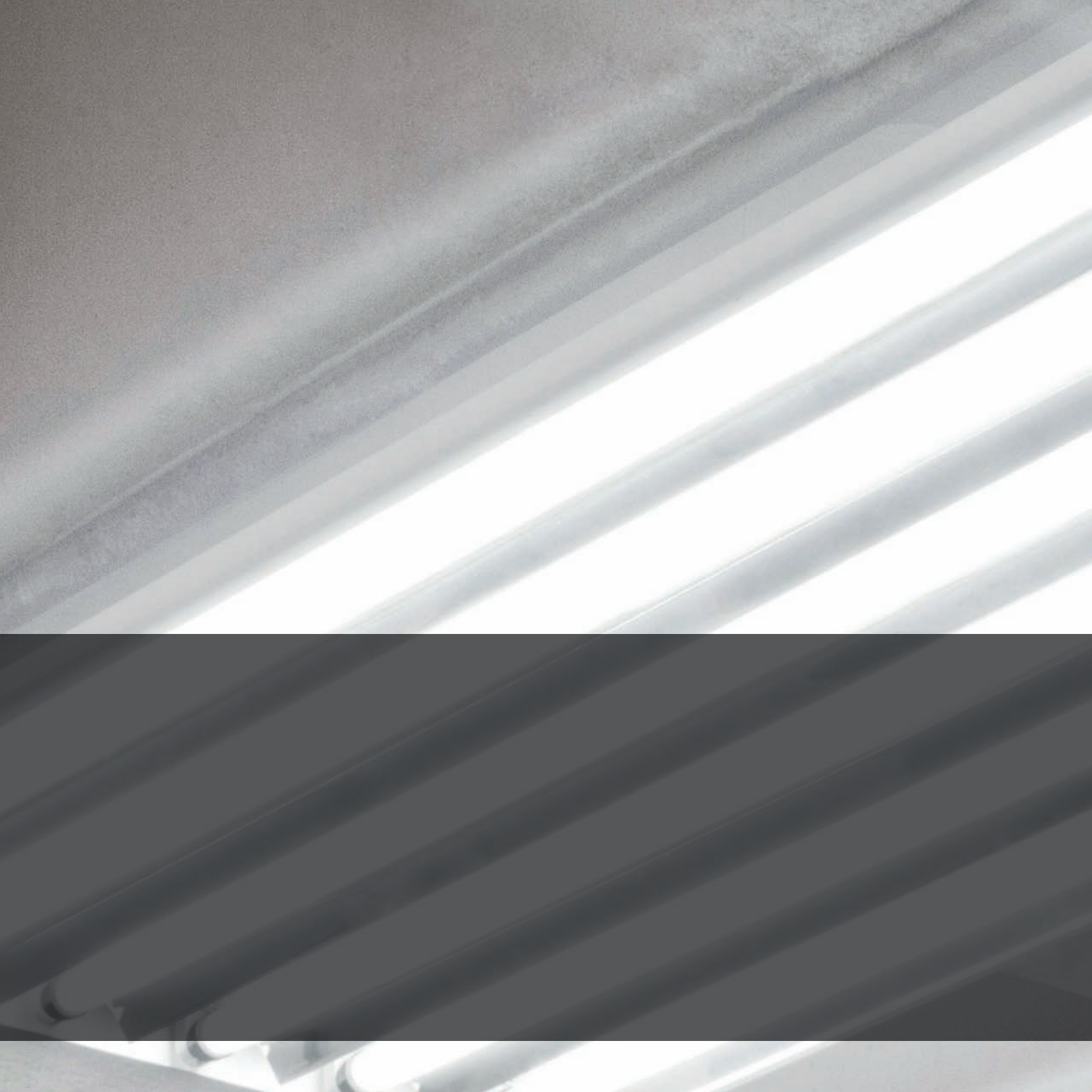



COMERCIAL INDUSTRIAL

GUÍA RÁPIDA DE LA SECCIÓN

PRODUCTO	K	LÁMPARA	COLOR	PAG.
OFFICE				
	4100 K 6500 K	T5	●	67
KROMOS I 3X14W EMPOTRAR				
	4100 K 6500 K	T5	●	67
KROMOS I 3X28W EMPOTRAR				
	3600 K 4100 K 6500 K	T5	●	67
KROMOS I 3X14W SOBREPONER				
	4100 K 6500 K	T5	●	67
KROMOS I 3X28W SOBREPONER				
	4100 K 6500 K	T5	●	68
KROMOS II 3X14W EMPOTRAR				
	4100 K 6500 K	T5	●	68
KROMOS II 3X14W SOBREPONER				
	4100 K 6500 K	T5	●	68
KROMOS II 3X28W EMPOTRAR				
	4100 K 6500 K	T5	●	68
KROMOS II 3X28W SOBREPONER				



PRODUCTO	K	LÁMPARA	COLOR	PAG.
	4100 K	G13	●	69
CUBIC 2X32W 9 CELDAS				
	4100 K	G13	●	69
CUBIC 2X32W 16 CELDAS				
	4100 K	G13	●	69
CUBIC 2X32W ACRÍLICO				
	4100 K	2G11	●	69
PIERCE 60X60				
	4100 K	G13	●	69
CUBIC 2X32W 18 CELDAS				

DIRIGIBLES

		G12	●	70
SLASH				

CAMPANAS

	--	E40	●	70
16"				
	--	E40	●	70
22"				
	6500 K	E26	●	70
14/85				

PRODUCTO	K	LÁMPARA	COLOR	PAG.
LINEALES IP 65				
	4100 K 6500 K	T8	●	71
GAMMA 1X32W T8, 2X32W T8				
	4100 K 6500 K	T5	●	71
GAMMA 1X54W T5, 2X54W T5				
	4100 K 6500 K	T5	●	71
GAMMA 2X28W T5				

LINEALES GABINETE

	4100 K 6500 K	T5	●	72
GRILL ACRÍLICO 2X54W T5, 2X80W T5				
	4100 K 6500 K	T5	●	72
GRILL ACRÍLICO 4X54W T5, 4X80W T5				
	4100 K 6500 K	T5	●	73
GRILL GABINETE 1X54W T5, 1X80W T5, 2X54W T5, 2X80W T5				
	4100 K 6500 K	T5	●	73
GRILL GABINETE 4X54W T5, 4X80W T5, 6X54W T5				

● BLANCO ● NEGRO ● GRIS

KROMOS I 3x14W EMPOTRAR

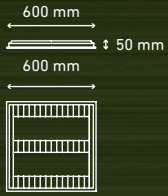

V	K	F.P.	CLAVE
90 - 140	4100	0.5	L2301-2F0
90 - 140	6500	0.5	L2301-2G0
100 - 305	4100	0.98	L2302-2F0
100 - 305	6500	0.98	L2302-2G0



KROMOS I 3x14W SOBREPONER

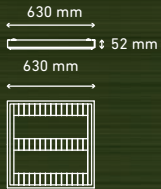

V	K	F.P.	CLAVE
90 - 140	3500	0.5	L2303-2J0
90 - 140	4100	0.5	L2303-2F0
90 - 140	6500	0.5	L2303-2G0
100 - 305	3500	0.98	L2304-2J0
100 - 305	4100	0.98	L2304-2F0
100 - 305	6500	0.98	L2304-2G0



KROMOS I 3x28W EMPOTRAR

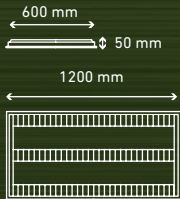

K	CLAVE
4100	L2305-2F0
6500	L2305-2G0



KROMOS I 3x28W SOBREPONER

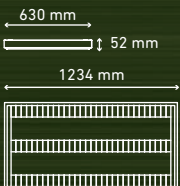

K	CLAVE
4100	L2306-2F0
6500	L2306-2G0



KROMOS II 3x14W EMPOTRAR

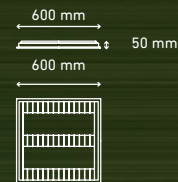

K	CLAVE
4100	L2310-2F0
6500	L2310-2G0

KROMOS II 3x14W SOBREPONER

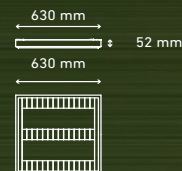

K	CLAVE
4100	L2311-2F0
6500	L2311-2G0

KROMOS II 3x28W EMPOTRAR

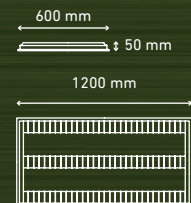

K	gr	CLAVE
4100	6050	L2312-2F0
6500	6150	L2312-2G0

KROMOS II 3x28W SOBREPONER

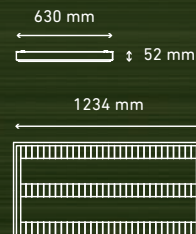
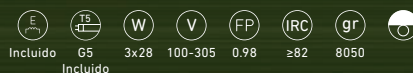

K	CLAVE
4100	L2313-2F0
6500	L2313-2G0

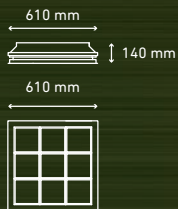

Includido G13 2x32 4100 ≥ 82 6368

V	F.P.	CLAVE
90-140	0.5	L2330-3F0
100-305	0.98	L2331-3F0

CUBIC 2x32W 9 CELDAS

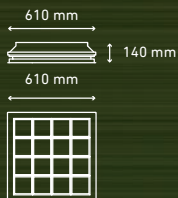
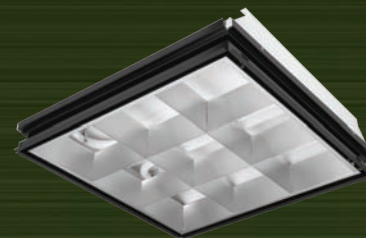

Includido G13 2x32 4100 0.5 ≥ 82 6374

V	CLAVE
90-140	L2340-1F0

CUBIC 2x32W 16 CELDAS

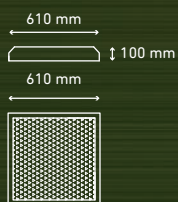

Includido G13 2x32 4100 90-140 ≥ 82 0.5 5197

V	CLAVE
90-140	L2351-1F0
90-140	L2350-1F0

CUBIC 2x32W ACRÍLICO

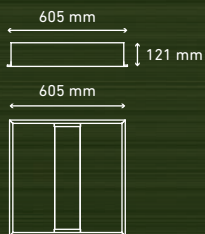
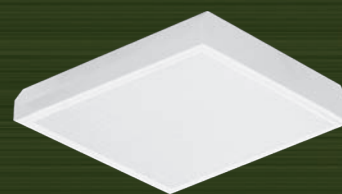

Includido 2611 2x40 100-305 4100 0.98 85 6300

CLAVE
L2320-1F0

PIERCE 60x60

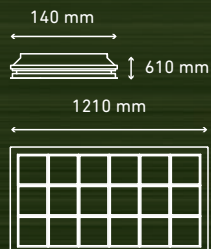

Includido T8 3x32 4100 0.98 ≥ 82 9000

V	CLAVE
90-140	L2360-3F0

CUBIC 3x32W 18 CELDAS

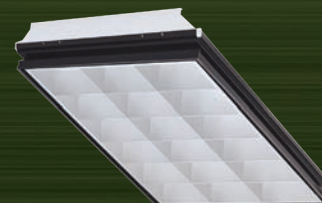

SLASH



No Incluido	G12 No Incluida	70 Máxima	1720 gr			176

CLAVE

*L2410-100



*SOBRE PEDIDO

16"



Incluido	E40 No Incluida	250 Máxima	127 220 277	0.98	8075	

COLOR

BLANCO

CLAVE

L1320-100

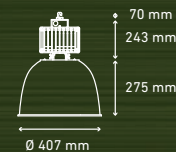

22"



Incluido	E40 No Incluida	127 220 277	0.98	

COLOR

BLANCO

W

250 Máxima
400 Máxima

gr

9401
10301

CLAVE

L1321-100
L1322-100

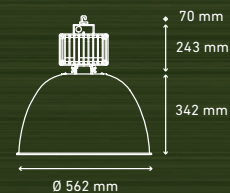

14/85



E26 Incluida	85	127	6500	0.5	

COLOR

GRIS ACERO

CLAVE

L2014-6G0

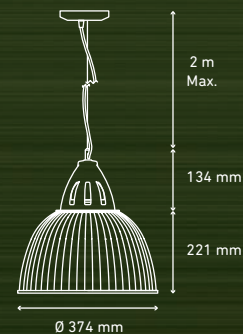

T5



1x32W T8



COLOR	K	CLAVE
GRIS	4100	L2605-5F0
GRIS	6500	L2605-5G0

1x54W T5



COLOR	K	CLAVE
GRIS	4100	L2603-5F0
GRIS	6500	L2603-5G0

2x28W T5



COLOR	V	K	F.P.	CLAVE
GRIS	100-305	4100	0.98	L2602-5F0
GRIS	90-140	4100	0.5	L2601-5F0
GRIS	90-140	6500	0.5	L2601-5G0

2x54W T5



COLOR	K	F.P.	CLAVE
GRIS	6500	0.98	L2608-5G0
GRIS	4100	0.98	L2608-5F0

T8

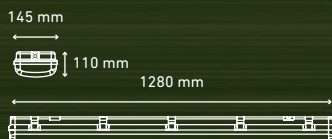

2x32W T8



COLOR	V	K	F.P.	CLAVE
GRIS	90-140	4100	0.5	L2607-5F0
GRIS	100-305	4100	0.95	L2606-5F0
GRIS	90-140	6500	0.5	L2607-5G0



GRILL ACRÍLICO

2x54W T5



COLOR	K	CLAVE
BLANCO	4100	L2610-1F0
BLANCO	6500	L2610-1G0



2x80W T5

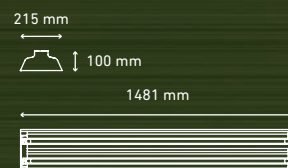

COLOR	K	CLAVE
BLANCO	4100	L2611-1F0
BLANCO	6500	L2611-1G0

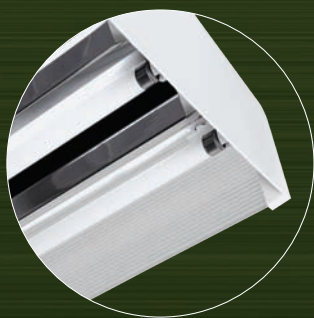

4x54W T5

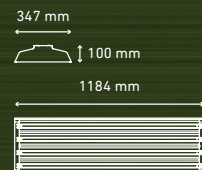

COLOR	K	CLAVE
BLANCO	4100	L2612-1F0
BLANCO	6500	L2612-1G0

4x80W T5

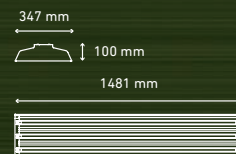

COLOR	K	CLAVE
BLANCO	4100	L2613-1F0
BLANCO	6500	L2613-1G0

**1x54W T5**

K CLAVE

4100	L2620-1F0
6500	L2620-1G0

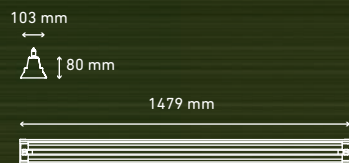
**1x80W T5**

K CLAVE

4100	L2621-1F0
6500	L2621-1G0

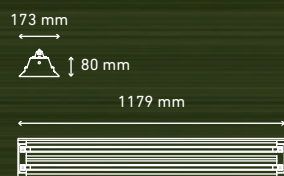
**2x54W T5**

K CLAVE

4100	L2622-1F0
6500	L2622-1G0

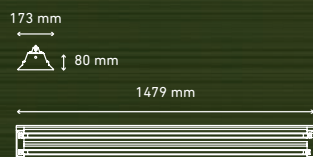
**2x80W T5**

K CLAVE

4100	L2623-1F0
6500	L2623-1G0

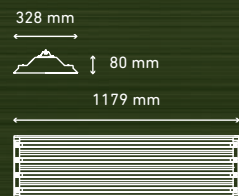
**4x54W T5**

K CLAVE

4100	L2624-1F0
6500	L2624-1G0

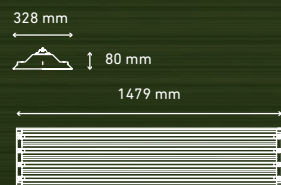
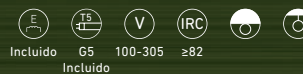
**4x80W T5**

K CLAVE

4100	L2625-1F0
6500	L2625-1G0

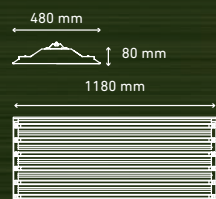
**6x54W T5**

K CLAVE

4100	L2626-1F0
6500	L2626-1G0







LÁMPARAS,
BALASTROS
Y ACCESORIOS

SHOT MR

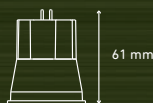
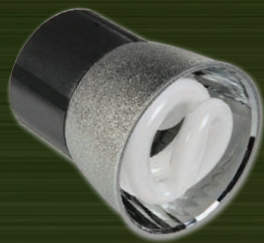

MR FLUORESCENTE

W	V	BASE	K	CLAVE	IRC	VIDA (h)
7	90 - 140	GU5.3/GX5.3	2700	B0471-000	≥80	10,000
	90 - 140	GU5.3/GX5.3	4100	B0472-000	≥80	10,000
	90 - 140	GU5.3/GX5.3	6500	B0482-000	≥80	10,000

ESPIRAL

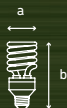

W	V	BASE	K	CLAVE	IRC	lm	VIDA (h)	DIMENSIONES (mm)
9	90 - 140	E26	2700	B0471-000	80	580	10,000	40 x 90
	90 - 140	E26	6500	B0472-000	80	470	10,000	40 x 90
13	90 - 140	E26	2700	B0482-000	80	870	10,000	47 x 95
	90 - 140	E26	6500	B0481-000	80	870	10,000	47 x 95
15	90 - 140	E26	2700	B0470-000	80	1010	10,000	50 x 95
	90 - 140	E26	6500	B0469-000	80	970	10,000	50 x 95
20	90 - 140	E26	2700	B0477-000	80	1900	10,000	56 x 105
	90 - 140	E26	6500	B0478-000	80	1900	10,000	56 x 105
26	90 - 140	E26	2700	B0479-000	80	1900	10,000	65 x 134
	90 - 140	E26	6500	B0480-000	80	1900	10,000	65 x 134
30	90 - 140	E26	2700	B0380-000	80	1940	10,000	70 x 145
	90 - 140	E26	6500	B0352-000	80	1980	10,000	70 x 145
45	90 - 140	E26	2700	B0423-000	80	3170	10,000	70 x 190
	90 - 140	E26	6500	B0366-000	80	3170	10,000	70 x 190
65	90 - 140	E26	2700	B0424-000	80	3870	10,000	80 x 215
	90 - 140	E26	6500	B0367-000	80	3820	10,000	80 x 215
	220	E26	6500	B0448-000	80	4000	10,000	80 x 215
85	127 +/- 10%	E26	6500	B0446-000	>80	6000	10,000	101 X 291.5

3U



W	V	BASE	K	CLAVE	IRC	lm	VIDA (h)	DIMENSIONES (mm)
14	90 - 140	E26	2700	F9117-000	80	710	8,000	25 x 120
	90 - 140	E26	4100	F9116-000	80	710	8,000	25 x 120
	90 - 140	E26	6500	F9115-000	80	660	10,000	36 X 118
26	90 - 140	E26	2700	B0115-000	82	1370	8,000	35 x 170
	90 - 140	E26	4100	B0111-000	82	1370	8,000	35 x 170
	90 - 140	E26	6500	B0116-000	80	1270	8,000	47 x 168

W	V	BASE	K	CLAVE	IRC	lm	VIDA (h)	DIMENSIONES (mm)
32	90 - 140	E26	6500	B0473-000	80	1720	8,000	120 x 150

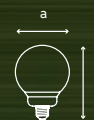

ESPIRAL

W	BASE	K	CLAVE	IRC	lm	VIDA (h)	DIMENSIONES (mm)
	GU21	2700	F9213-000	85	780	10,000	45 x 55
	GU21	4100	F9214-000	85	820	10,000	45 x 55
13	GU21	6500	F9215-000	85	790	10,000	45 x 55
	G24q-1	2700	F9093-000	80	930	8,000	40 x 90
	G24q-1	4100	F9090-000	80	930	8,000	40 x 90
65	E40	6500	F9174-000	80	4000	10,000	80 x 215



U

W	BASE	K	CLAVE	IRC	lm	VIDA (h)	DIMENSIONES (mm)
9	G23	4100	F9071-000	80	590	8,000	25 x 180
13	GX23	2700	F9072-000	80	780	8,000	25 x 180
	GX23	4100	F9073-000	80	780	8,000	25 x 180



2U

W	BASE	K	CLAVE	IRC	lm	VIDA (h)	DIMENSIONES (mm)
	GX23-2	2700	F9076-000	80	740	8,000	25 x 115
	GX23-2	4100	F9077-000	80	740	8,000	25 x 115
13	G24q-1	2700	F9129-000	80	800	8,000	25 x 130
	G24q-1	4100	F9128-000	80	800	8,000	25 x 130
	G24d-3	4100	F9051-000	80	1890	10,000	20 x 165
26	G24q-3	2700	F9080-000	80	1890	10,000	20 x 165
	G24q-3	4100	F9082-000	80	1890	10,000	20 x 165



3U



W	BASE	K	CLAVE	IRC	lm	VIDA (h)	DIMENSIONES (mm)
32	GX24q-3	4100	F9060-000	80	2240	10,000	35 x 145
42	GX24q-4	4100	F9031-000	80	2800	10,000	35 x 165

4U



W	BASE	K	CLAVE	IRC	lm	VIDA (h)	DIMENSIONES (mm)
65	E40	6500	F9000-000	80	4000	10,000	72 x 223

ADAPTADOR CON BALASTRO ELECTROMAGNÉTICO PARA LFC



DESCRIPCION	BASE	CLAVE	DIMENSIONES (mm)
9 W AD9C	E26	B0199-000	35 x 78
13 W AD13C	E26	B0160-200	35 x 78

LÁMPARAS CIRCULARES T5



CIRCULARES T5 SUPER

W	BASE	K	CLAVE	IRC	lm	VIDA (h)	DIMENSIONES (mm)
18	G10q	5000	F9089-000	80	1160	10,000	20 x 150
28	G10q	5000	F9091-000	75	1780	10,000	20 x 225
38	G10q	5000	F9092-000	80	2690	10,000	20 x 300
48	G10q	5000	F9161-000	80	3610	10,000	20 x 375

• SOBRE PEDIDO

LÁMPARAS LINEALES T5 Y T8

W	DIAMETRO	BASE	K	CLAVE	IRC	lm	VIDA (h)	DIMENSIONES (mm)
8	T5	G5	3500	F9216-000	82	440	20,000	16 x 302
	T5	G5	4100	F9217-000	82	440	20,000	16 x 302
	T5	G5	6500	F9218-000	82	440	20,000	16 x 302
14	T5	G5	3500	F9206-000	84	1120	20,000	15 x 560
	T5	G5	4100	F9141-000	85	1090	20,000	15 x 560
	T5	G5	6500	F9201-000	84	1120	20,000	15 x 560
21	T5	G5	3500	F9207-000	86	1870	20,000	15 x 860
	T5	G5	4100	F9142-000	85	1870	20,000	15 x 860
	T5	G5	6500	F9202-000	86	1870	20,000	15 x 860
24	T5	G5	4100	F9106-000	83	1810	20,000	15 x 560
	T5	G5	6500	F9211-000	83	1600	20,000	15 x 560
28	T5	G5	3500	F9208-000	82	2530	20,000	15 x 116
	T5	G5	4100	F9143-000	82	2540	20,000	15 x 116
	T5	G5	6500	F9203-000	82	2540	20,000	15 x 116
32	T8	G13	4100	F9103-000	85	2790	12,000	25 x 1212
	T8	G13	5000	F9225-000	82	2750	12,000	25 x 1212
	T8	G13	6500	F9200-000	86	2790	12,000	25 x 1212
35	T5	G5	4100	F9144-000	85	3290	20,000	15 x 1462
	T5	G5	6500	F9204-000	85	3290	20,000	15 x 1462
54	T5	G5	3500	F9210-000	82	4770	20,000	15 x 116
	T5	G5	4100	F9145-000	82	4770	20,000	15 x 116
	T5	G5	6500	F9205-000	82	4770	20,000	15 x 116
80	T5	G5	6500	F9110-000	81	6310	20,000	15 x 1462



LÁMPARAS TIPO U T8

TIPO U T8

W	BASE	K	CLAVE	IRC	lm	VIDA (h)	DIMENSIONES (mm)
32	G13	4100	F9131-000	85	2390	16,000	25 x 430



MR11



W	ÁNGULO	V	BASE	K	CLAVE	VIDA (h)
35	38°	12	GU4	3000	F9046-000	3,000

MR16



W	ÁNGULO	V	BASE	K	CLAVE	VIDA (h)
20	38°	12	GU5.3	3000	F9049-000	3,000
35	38°	12	GU5.3	3000	F9105-000	3,000
	38°	12	GU5.3	3000	F9047-000	3,000
50	38°	12	GU5.3	3000	F9119-000	1,000
	38°	127	GU5.3	3000	F9118-000	2,000
	40°	127	GU10	2700	F9114-000	1,500

AR111

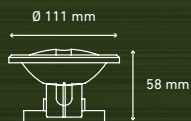

W	ÁNGULO	V	BASE	K	CLAVE	VIDA (h)
50	24°	12	G53	3000	F8010-000	3,000

T13

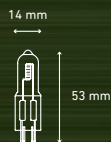

W	V	BASE	K	CLAVE	VIDA (h)
40	127	G9	2700	F9111-000	1,500

ADITIVOS METÁLICOS CERÁMICOS (CDM)

W	DESCRIPCIÓN	BASE	K	CLAVE	IRC	lm	VIDA (h)
35	* CDM-TC	G8.5	3000	F8030-000	85	3400	10,000
	CDM-TC	G8.5	4000	F8031-000	87	3400	10,000
	CDM-TC	G8.5	3000	F8028-000	88	6480	10,000
70	CDM-TC	G8.5	4000	F8029-000	94	6420	10,000
	CDM-T	G12	4000	F8033-000	94	6450	10,000
150	CDM-T	G12	3000	F8026-000	87	14840	10,000
	* CDM-T	G12	4000	F8027-000	92	14840	10,000

• SOBRE PEDIDO

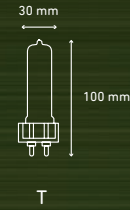

ADITIVOS METÁLICOS (MH)

W	DESCRIPCIÓN	BASE	K	CLAVE	IRC	lm	VIDA (h)
70	MH-TD	RX7s	4000	F8003-000	70	6030	10,000
	MH-T	G12	3000	F8020-000	70	6500	10,000
	MH-T	G12	4000	F8019-000	70	6500	10,000
150	MH-TD	RX7s	4000	F8005-000	70	16220	10,000

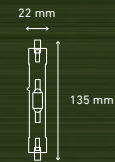

TD 70W



TD 150W



W	LÁMPARAS	V	ENCENDIDO	FP	CLAVE	CONEXIÓN	DIMENSIONES (mm)	a	b	c	x	y	ø
17	2	90 - 140	Instantáneo	0.98	B0437-100	C04	D02	230	30	28	221	20	5
25	2	90 - 140	Instantáneo	0.98	B0437-100	C04	D02	230	30	28	221	20	5
32	1	90 - 140	Rápido	0.5	B0449-100	C01	D01	168	26	19	157	-	4.2
	2	90 - 140	Rápido	0.5	B0534-100	C11	D01	210	28	22	202	20	4.2
	2	90 - 140	Instantáneo	0.5	B0434-100	C04	D02	177	30	28	167	20	5
	2	90 - 140	Instantáneo	0.98	B0437-100	C04	D02	230	30	28	221	20	-
	2	100 - 305	Rápido	0.98	B0396-000	C04	D01	210	28	22	202	20	4.2
	3	100 - 305	Rápido	0.95	B0436-000	C14	D02	268	44	35	258	-	5

DIMENSIONES

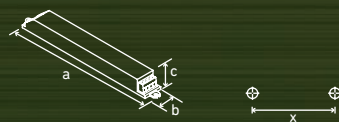

D01

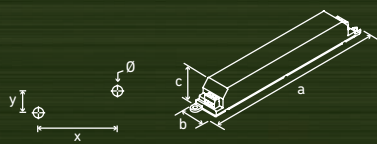

D02

CONEXIONADO



C01



C04

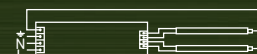

C11



C14

W	LÁMPARAS	V	ENCENDIDO	FP	CLAVE	CONEXIÓN	DIMENSIONES (mm)						
							a	b	c	x	y	ø	
	1	90 - 140	Rápido	0.5	B0404-100	C01	D01	168	26	19	157	-	4.2
14	3	90 - 140	Instantáneo	0.5	B0386-100	C03	D07	70	102	32	60	93	5
	3	100 - 305	Instantáneo	0.98	B0394-000	C03	D04	125	63	31	118	-	4
21	1	90 - 140	Rápido	0.5	B0405-100	C01	D01	168	26	19	157	-	4.2
24	2	90 - 140	Instantáneo	0.5	B0389-000	C04	D02	205	29	27	195	19	5
	1	90 - 140	Rápido	0.5	B0406-100	C01	D01	168	26	19	157	-	4.2
	2	90 - 140	Rápido	0.5	B0408-100	C11	D01	210	28	22	202	-	4.2
28	2	100 - 305	Rápido	0.98	B0396-000	C11	D01	267	30	29	256	-	5
	3	90 - 140	Instantáneo	0.98	B0416-000	C12	D03	149	80	39	139	70	4
	3	100 - 305	Rápido	0.98	B0413-000	C09	D02	268	44	35	258	33	5
35	1	90 - 140	Rápido	0.5	B0407-100	C01	D01	168	26	19	157	-	4.2
39	1	90 - 140	Rápido	0.5	B0571-000	C01	D01	168	26	19	157	-	4.2
	1	90 - 140	Rápido	0.5	B0379-200	C01	D01	210	28	22	202	-	4.2
54	1	100 - 305	Rápido	0.98	B0398-100	C02	D01	267	30	29	256	-	5
	2	100 - 305	Rápido	0.98	B0430-000	C16	D02	302	32	30	293	-	5
80	1	100 - 305	Rápido	0.98	B0559-000	C02	D02	306	30	28	296	20	5

DIMENSIONES

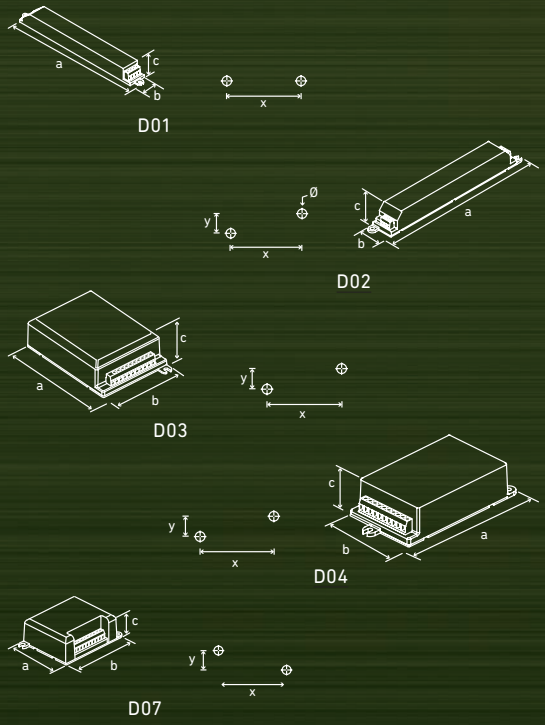

CONEXIONADO

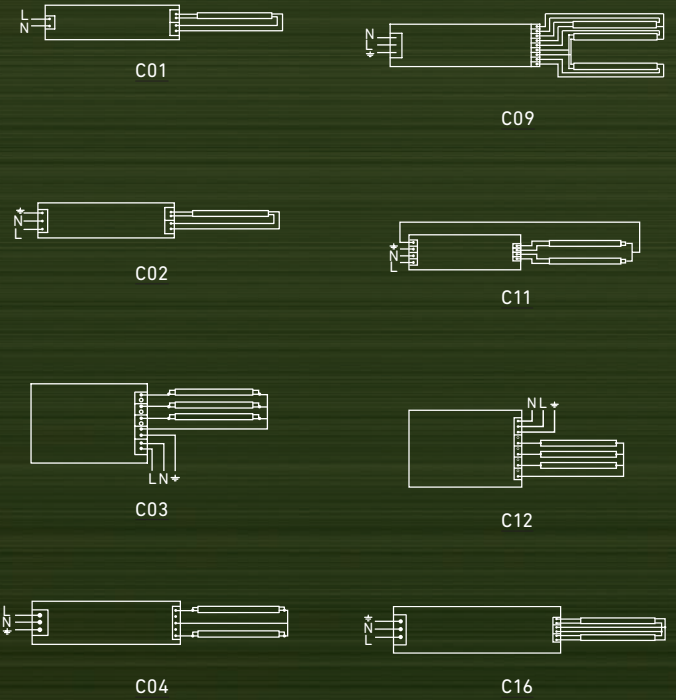

LÁMPARAS FLUORESCENTES COMPACTAS

W	LÁMPARAS	V	ENCENDIDO	FP	CLAVE	CONEXIÓN	DIMENSIONES (mm)						
							a	b	c	x	y	ø	
13	1	90 - 140	Rápido	0.5	B0494-000	C17	D08	92	50	26	-	-	-
	1	90 - 140	Rápido	0.5	B0427-000	C18	D09	93	61	30	-	-	-
	1	90 - 140	Rápido	0.5	B0109-000	C18	D11	63	44	30	-	-	-
26	2	90 - 140	Rápido	0.5	B0419-000	C19	D10	120	37	30	112	-	4
	1	90 - 140	Rápido	0.5	B0362-000	C23	D11	91	57	30	81	44	3.4
	2	90 - 140	Instantáneo	0.5	B0390-100	C24	D04	125	63	31	118	-	4
32	2	100 - 305	Rápido	0.98	B0392-000	C06	D06	124	78	30	115	-	4
	2	100 - 305	Rápido	0.98	B0411-100	C06	D06	124	78	30	115	-	4
42	1	100 - 305	Rápido	0.98	B0392-000	C06	D06	124	78	30	115	-	4
	2	100 - 305	Rápido	0.98	B0411-100	C06	D06	124	78	30	115	-	4

DIMENSIONES

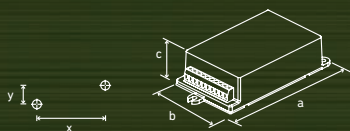

D04

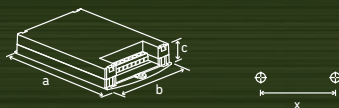

D06



D08

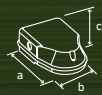

D09

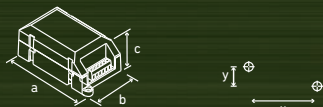

D11

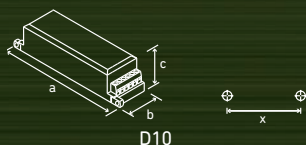

D10

CONEXIONADO

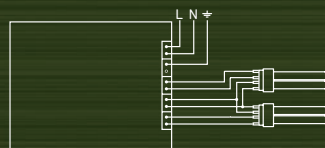

C06

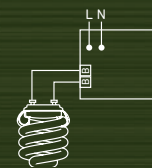

C17

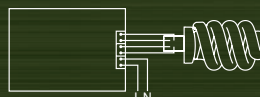

C18



C19

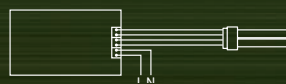

C23

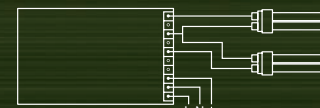

C24



CIRCULAR T5

W	LÁMPARAS	V	ENCENDIDO	FP	CLAVE	CONEXIÓN	DIMENSIONES (mm)	a	b	c	x	y	ø
18	1	90 - 140	Rápido	0.5	B0171-100	C05	D13	93	47	32	85	38	3
26	1	90 - 140	Rápido	0.5	B0172-100	C05	D13	93	47	32	85	38	3
34	1	90 - 140	Rápido	0.5	B0173-100	C05	D13	90	56	30	82	46	3

CIRCULAR T9

W	LÁMPARAS	V	ENCENDIDO	FP	CLAVE	CONEXIÓN	DIMENSIONES (mm)	a	b	c	x	y	ø
22	1	90 - 140	Rápido	0.5	B0113-000	C05	D13	93	47	32	85	38	3

DIMENSIONES

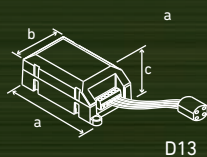

D13

CONEXIONADO

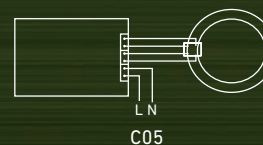

C05



ADITIVO METÁLICO

W	LÁMPARAS	V	FP	CLAVE	CONEXIÓN	DIMENSIONES (mm)					
						a	b	c	x	y	
35	CDM-TC	100 - 305	0.98	B0492-000	C26	D14	138	76	32	115	40
70	CDM-TC, CDM-T, CDM-PAR38, MH-T	100 - 305	0.98	B0495-000	C26	D14	153	76	32	129	40
150	CDM-T, MH-TD	90 - 240	0.98	B0518-000	C26	D14	177	79	34	171	46

DIMENSIONES

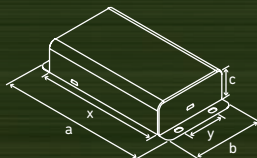

D14

CONEXIONADO

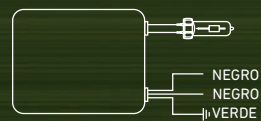

C26

ADITIVOS METÁLICOS (MH) Y ADITIVOS METÁLICOS CERÁMICOS (CDM)

W	LÁMPARAS	V	FP	CLAVE	PESO	DIMENSIONES (mm)					
						a	b	c	x	y	
70	MH-TD, MH-T, CDM-T	220	0.5	A1119-500	1048	D39	96	62	60	85	-
150	MH-TD, MH-T, CDM-T	220	0.5	A1120-800	1576	D39	96	81	60	85	-



D39

EQUIPOS PARA HID Y CDM

W	LÁMPARAS	V	FP	CLAVE	PESO	DIMENSIONES (mm)					
						a	b	c	x	y	
70	MH-TD, MH-T, CDM-T	220	0.9	B0064-000	1823	D31	177	140	64	127	127
150	MH-TD, MH-T, CDM-T	220	0.9	B0065-000	2361	D31	177	140	64	127	127

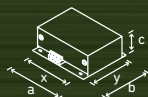

D31

BALASTROS ELECTROMAGNÉTICOS FLUORESCENTES

FC						DIMENSIONES (mm)					
W	LÁMPARAS	V	FP	CLAVE	PESO	a	b	c	x	y	
13	1	127	0.5	A0769-200	232	D34	70	34	43	60	127
	1	127	0.5	A1612-400	233	D35	57	36	50	36	-



D34



D35

W	CORRIENTE DE SALIDA MAX	FP	CLAVE	PESO	DIMENSIONES (mm)	a	b	c	x	y
70	0.45 A	0.91	A1001-700	1000	D27	67	56	57	72	55
150	1.4 A	0.98	A0892-500	1500	D27	67	56	57	9	65

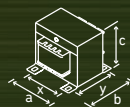

D27

CAPACIDAD EN VA	CARACTERISTICAS ADICIONALES			CLAVE	PESO	DIMENSIONES (mm)	a	b	c	x	y
	T/A	A/T	S/B								
6	•	-	-	A2537-000	0.16	D30	34	44	23	-	-
50	-	•	-	A1382-200	0.72	D28	58	57	48	-	-
50	•	-	-	A1474-100	0.68	D28	58	57	48	-	-
100	•	-	•	A0239-200	1.8	D27	86	79	75	70	61
200	•	-	-	A1374-100	2.5	D29	105	77	104	75	61
300	•	-	-	A1375-100	3.3	D29	105	92	104	74	75
500	•	-	-	A0784-000	5.4	D29	115	111	112	85	95

NOMENCLATURA

T/A: TEMPERATURA AMBIENTE
 A/T: ALTA TEMPERATURA
 S/B: SIN BASE

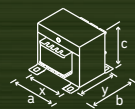

D27

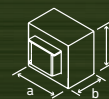

D28

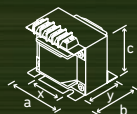

D29



D30

COLOR	W	CLAVE	VOLTAJE DE ALIMENTACIÓN (IN)	VOLTAJE DE SALIDA (OUT)
BLANCO	50	B0076-000	127V~± 10%	12V
• NEGRO	50	B0077-000	127V~± 10%	12V
GRIS	50	B0077-200	127V~± 10%	12V

• SOBRE PEDIDO

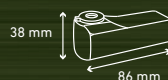

RIEL ECONÓMICO

COLOR	W	CLAVE	VOLTAJE DE ALIMENTACIÓN (IN)	VOLTAJE DE SALIDA (OUT)
• BLANCO	50	B0090-000	127V~± 10%	12V
• NEGRO	50	B0090-100	127V~± 10%	12V

• SOBRE PEDIDO



USO GENERAL

COLOR	W	CLAVE	VOLTAJE DE ALIMENTACIÓN (IN)	VOLTAJE DE SALIDA (OUT)
BLANCO	50	B0174-200	127V~± 10%	12V

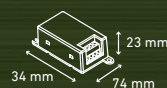

MINIMAGG ENCAPSULADO

COLOR	W	CLAVE	VOLTAJE DE ALIMENTACIÓN (IN)	VOLTAJE DE SALIDA (OUT)
NEGRO	50	B0191-000	127V~± 10%	12V

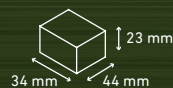

USO GENERAL ENCAPSULADO

W	CLAVE	VOLTAJE DE ALIMENTACIÓN (IN)	VOLTAJE DE SALIDA (OUT)
50	B0531-000	277V~± 10%	12V

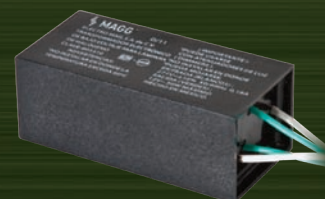
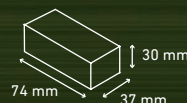

ARILLOS 1x13W

SHOT II ARILLO Ø 158 mm

OPEN



STEEL

CENTER



CENTER MADERA



CAOBA



CEREZO

OPEN



NÍQUEL SATÍN

FROSTED



NÍQUEL SATÍN

SHOT II ARILLO Ø 175 mm

OPEN



CENTER



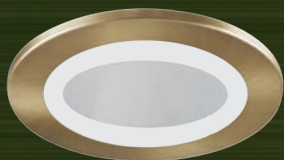

BRASS

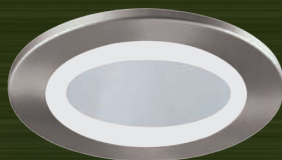

NÍQUEL SATÍN

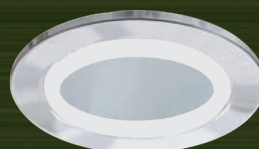

CROMO

ARILLOS SUSPENDIDOS

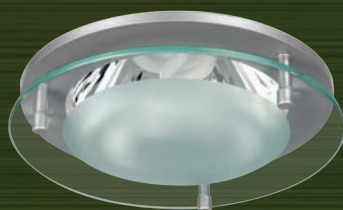
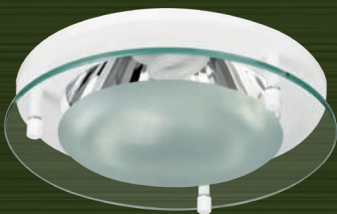

2x26W

COLOR	CLAVE
• BLANCO	P0145-000
• NÍQUEL SATÍN	P0145-500

• SOBRE PEDIDO

COLOR	CLAVE	DESCRIPCIÓN
• BLANCO	P0137-000	ARILLO SHOT II OPEN Ø 175 mm
• NEGRO	P0137-100	ARILLO SHOT II OPEN Ø 175 mm
• BLANCO	P0181-000	ARILLO SHOT II CENTER Ø 175 mm
• NEGRO	P0181-100	ARILLO SHOT II CENTER Ø 175 mm
• BLANCO	P0190-000	ARILLO SHOT II OPEN Ø 158 mm
• NEGRO	P0190-100	ARILLO SHOT II OPEN Ø 158 mm
• BLANCO	P0191-000	ARILLO SHOT II CENTER Ø 158 mm
• NEGRO	P0191-100	ARILLO SHOT II CENTER Ø 158 mm

• SOBRE PEDIDO

COLOR	CLAVE	DESCRIPCIÓN
NÍQUEL SATÍN	P0160-500	ARILLO STEEL OPEN
NÍQUEL SATÍN	P0161-500	ARILLO STEEL CENTER
BRASS	P0161-600	ARILLO STEEL CENTER
CROMO	P0161-400	ARILLO STEEL CENTER
NÍQUEL SATÍN	P0162-500	ARILLO STEEL FROSTED
CAOBA	P0146-300	ARILLO SHOT EXTRA MINI
CEREZO	P0146-500	ARILLO SHOT EXTRA MINI

LOW VOLTAGE



SOCKET MR16

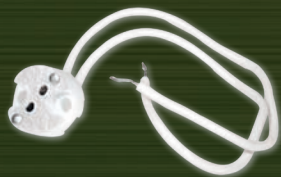

SOCKET GU10

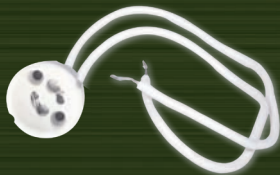

RIELES

COLOR	CLAVE	DESCRIPCIÓN
BLANCO	R1001-000	RIEL 0,50 m 127 V
BLANCO	R1002-000	RIEL 0,60 m 127 V
BLANCO	R1003-000	RIEL 1,00 m 127 V
NEGRO	R1003-100	RIEL 1,00 m 127 V
BLANCO	R1004-000	RIEL 1,20 m 127 V
NEGRO	R1004-100	RIEL 1,20 m 127 V
BLANCO	R1005-000	RIEL 2,00 m 127 V
NEGRO	R1005-100	RIEL 2,00 m 127 V
BLANCO	R1006-000	RIEL 2,40 m 127 V
NEGRO	R1006-100	RIEL 2,40 m 127 V

SOCKET

CLAVE	DESCRIPCIÓN
B0053-000	SOCKET PARA LÁMPARA DICROICA MR11/ MR16
P0217-000	SOCKET PARA LÁMPARA GU10

BASES

BASE DE 13W



BASE DE 26W



CLAVE

CLAVE	DESCRIPCIÓN
B0155-000	BASE PARA LFC 13W SENCILLA Y DOBLE
P0051-000	BASE PARA LFC 26W CUATRO PINES

PANTALLA 260

COLOR	CLAVE	DESCRIPCIÓN
• BLANCO	P0011-000	PANTALLA PARA ROUND 26
• BLANCO	P0029-000	PANTALLA PARA ROUND 34
• BLANCO	P0041-000	PANTALLA PARA HELIX 26
• BLANCO	P0056-000	PANTALLA PARA HELIX 34
• BLANCO	P0042-000	PANTALLA PARA GEMA 26
• BLANCO	P0039-000	PANTALLA PARA GEMA 34
• BLANCO	P0095-000	PANTALLA 205
• BLANCO	P0097-000	PANTALLA 250
• BLANCO	P0098-000	PANTALLA 260
• BLANCO	P0103-000	PANTALLA 305
• BLANCO	P0108-000	PANTALLA 350
• BLANCO	P0109-000	PANTALLA 360
• BLANCO	P0117-000	PANTALLA DIAMANTE S10
• BLANCO	P0118-000	PANTALLA DIAMANTE S20



PANTALLA PARA GEMA



• SOBRE PEDIDO

MASTER LINE

TENSIÓN DE LÍNEA EN VOLTS	CLAVE	DESCRIPCIÓN
220V	B0039-000	IGNITOR PARA HQI O MASTER COLOUR 70/150 W
220V	E1050-000	CAPACITOR PARA HQI O MASTER COLOUR 150 W

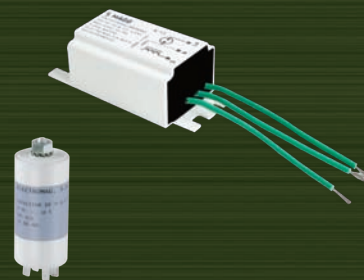

SECURITY

BRAZO METÁLICO MEDIANO Ø 40 mm



CLAVE
P0010-000



BRAZO METÁLICO LARGO Ø 40 mm

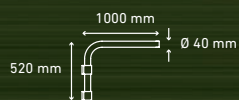

CLAVE
P0009-000



COPLE CITI 20



CLAVE

P0001-000

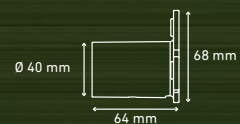

FOTOCONTROL PARA RECEPTÁCULO

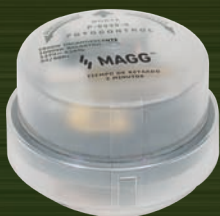

CLAVE	VOLTAJE DE ALIMENTACIÓN (IN)	CARGA MÁXIMA
P0030-000	127V~± 10%	1800 W INCANDESCENTE
P0040-000	220V~± 10%	900 W INCANDESCENTE

FOTOCONTROL COMPACTO EMPOTRABLE



CLAVE	VOLTAJE DE ALIMENTACIÓN (IN)	CARGA MÁXIMA
P0090-000	127V~± 10%	500 W INCANDESCENTE
P0071-000	220V~± 10%	1800 W INCANDESCENTE

FOTOCONTROL COMPACTO EMPOTRABLE ELECTRÓNICO



CLAVE	VOLTAJE DE ALIMENTACIÓN (IN)	CARGA MÁXIMA
P0175-000	127V~± 10%	300 W INCANDESCENTE

BASE SISTEMA MODULAR GAMMA

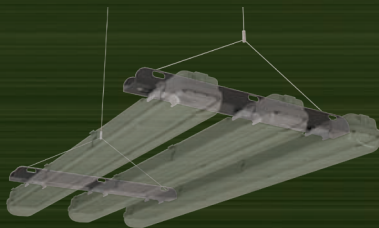

SISTEMA MODULAR DOBLE

CLAVE
P0246-000

SISTEMA MODULAR TRIPLE

CLAVE
P0248-000

REFRACTOR

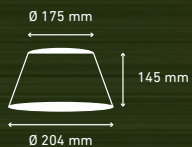

REFRACTOR DE
POLICARBONATO 100%

CLAVE

P0013-000



ESTACAS



ESTACA

CLAVE

P0088-000



ESTACA FLAT

CLAVE

P0120-000

HERRAJES



HERRAJE FLAT 150
VERTICAL

CLAVE

P0139-000



HERRAJE FLAT 190
VERTICAL

CLAVE

P0141-000

CONECTORES

CONECTOR	IP	CLAVE
T	68	P0058-000
I	68	P0059-000



CONECTOR T

CONECTOR I

BRACKET

BRACKET DIRIGIBLE
PARA BL LED

CLAVE

P0007-000



BRACKET FIJO
PARA BL LED

CLAVE



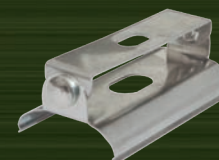
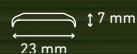











P0263-000



CATEGORÍA IP

PRIMER DIGITO

SEGUNDO DIGITO

IP	PROTECCIÓN CONTRA OBJETOS	EFFECTIVIDAD	IP	PROTECCIÓN CONTRA OBJETOS	DETALLES		
0		Ninguna	Ninguna protección contra intrusión de objetos.	0		Sin protección	
1		>50mm	Superficies grandes del cuerpo, como pies o manos u objetos similares.	1		Goteo de agua	El goteo del agua (en gotas verticales que caen) no causara daños en el equipo.
2		>12.5mm	Dedos u objetos similares.	2		Agua goteando a 15°	El goteo vertical de agua no causara daños en el equipo cuando el ángulo que forman es menor de 15° desde su posición normal.
3		>2.5mm	Herramientas, cables gruesos, etc.	3		Agua rociada	Agua que cae en cualquier ángulo superior a 60° desde la vertical no causara daños.
4		>1mm	Mayoría de los cables, tornillería, etc.	4		Chorro de agua	Chorro de agua desde cualquier dirección no tendrá efectos dañinos.
5		Polvo	La intrusión de polvo no esta completamente garantizada, pero es bastante satisfactoria; protección completa de los contactos.	5		Potente chorro de agua	Chorro de agua a presión desde cualquier dirección no tendrá efectos dañinos.
6		Polvo fino	Ninguna penetración de polvo; protección completa de los contactos.	6		Goteo de agua	El agua de mar / oleada a presión directa hacia el equipo desde cualquier dirección no tendrá grandes efectos de daños.
				7		Inmersión a 1m	No tendrá grandes efectos de daños cuantitativos para el equipo su inmersión en agua en condiciones definidas de presión y tiempo (a 1m de inmersión)
				8		Sumersión a mas de 1m	No habrá daños para el equipo derivados de su inmersión en agua en condiciones definidas por las especificaciones o el fabricante (a mas de 1m de sumersión)

NOTA:
Normalmente, esto significara que el equipo esta aislado herméticamente. Sin embargo en ciertos tipos de equipos, esto puede significar que el agua puede penetrar pero solo en una manera que no produce efectos perjudiciales.

GLOSARIO

LUMEN

Unidad de medida de la cantidad de luz emitida por una fuente lumínica. Se mide en lúmenes (lm).

TEMPERATURA DE COLOR (K)

Unidad de medida que se refiere al aspecto general del color de la luz y se expresa en unidades de grados Kelvin, donde las temperaturas entre 2700 K a 3000 K representan la "luz cálida", 4000 K "luz neutra" y 4500 K o mayor, "luz fría".

WATT (W)

Unidad utilizada para medir el consumo de energía de la lámpara o luminaria.

ÍNDICE DE REPRODUCCIÓN CROMÁTICA (IRC)

Medida de la capacidad que una fuente luminosa tiene para reproducir fielmente los colores en comparación con la luz del sol.

Se mide en una escala de 0 a 100, a mayor IRC de una fuente de luz, más naturales se verán los colores debajo de ella, es decir, más parecido a como se verían bajo la luz solar. Las fuentes de luz con bajo IRC tienden a distorsionar la percepción del color.



CLAVES

CLAVE	PÁGINA	CLAVE	PÁGINA	CLAVE	PÁGINA	CLAVE	PÁGINA
		B0199-000	78	B0477-000	76	F9071-000	77
A		B0352-000	76	B0478-000	76	F9072-000	77
		B0362-000	84	B0479-000	76	F9073-000	77
A0239-200	88	B0366-000	76	B0480-000	76	F9076-000	77
A0769-200	87	B0367-000	76	B0481-000	76	F9077-000	77
A0784-000	88	B0379-200	83	B0482-000	76	F9080-000	77
A0892-500	88	B0380-000	76	B0492-000	86	F9082-000	77
A1001-700	88	B0386-100	83	B0494-000	84	F9089-000	78
A1119-500	87	B0389-000	83	B0495-000	86	F9090-000	77
A1120-800	87	B0390-100	84	B0518-000	86	F9091-000	78
A1374-100	88	B0392-000	84	B0531-000	89	F9092-000	78
A1375-100	88	B0392-000	84	B0534-100	82	F9093-000	77
A1382-200	88	B0394-000	83	B0559-000	83	F9103-000	79
A1474-100	88	B0396-000	82	B0571-000	83	F9105-000	80
A1612-400	87	B0396-000	82	E		F9106-000	79
A2537-000	88	B0398-100	83			F9110-000	79
		B0404-100	83	E1050-000	93	F9111-000	80
B		B0405-100	83			F9114-000	80
		B0406-100	83	F		F9115-000	76
B0039-000	93	B0407-100	83			F9116-000	76
B0053-000	92	B0408-100	83	F8003-000	81	F9117-000	76
B0064-000	87	B0411-100	84	F8005-000	81	F9118-000	80
B0065-000	87	B0413-000	83	F8010-000	80	F9119-000	80
B0076-000	89	B0416-000	83	F8019-000	81	F9128-000	77
B0077-000	89	B0419-000	84	F8020-000	81	F9129-000	77
B0077-200	89	B0423-000	76	F8026-000	81	F9131-000	79
B0090-000	89	B0424-000	76	F8027-000	81	F9141-000	79
B0090-100	89	B0427-000	84	F8028-000	81	F9142-000	79
B0109-000	84	B0430-000	83	F8029-000	81	F9143-000	79
B0111-000	76	B0434-100	82	F8030-000	81	F9144-000	79
B0113-000	85	B0436-000	82	F8031-000	81	F9145-000	79
B0115-000	76	B0437-100	82	F8033-000	81	F9161-000	78
B0116-000	76	B0446-000	76	F9000-000	78	F9174-000	77
B0155-000	92	B0448-000	76	F9031-000	78	F9200-000	79
B0160-200	78	B0449-100	82	F9046-000	80	F9201-000	79
B0171-100	85	B0469-000	76	F9047-000	80	F9202-000	79
B0172-100	85	B0470-000	76	F9049-000	80	F9203-000	79
B0173-100	85	B0471-000	76	F9051-000	77	F9204-000	79
B0174-200	89	B0472-000	76	F9060-000	78	F9205-000	79
B0191-000	89	B0473-000	77			F9206-000	79



CLAVE	PÁGINA	CLAVE	PÁGINA	CLAVE	PÁGINA	CLAVE	PÁGINA
F9207-000	79	L1031-B10	6	L1210-CG0	17	L1601-800	22
F9208-000	79	L1032-B10	8	L1211-CF0	17	L1602-100	22
F9210-000	79	L1040-B10	6	L1211-CG0	17	L1602-300	22
F9211-000	79	L1101-1H0	11	L1212-CF0	17	L1602-800	22
F9213-000	77	L1102-1H0	11	L1212-CG0	17	L1603-100	22
F9214-000	77	L1103-1H0	12	L1302-100	18	L1603-300	22
F9215-000	77	L1110-1H0	11	L1302-600	18	L1603-800	22
F9216-000	79	L1111-1H0	11	L1311-100	18	L1610-300	23
F9217-000	79	L1112-1H0	12	L1311-800	18	L1610-800	23
F9218-000	79	L1120-1E0	13	L1312-100	18	L1611-300	23
F9225-000	79	L1120-1H0	13	L1312-800	18	L1611-800	23
		L1121-1E0	13	L1320-100	70	L1612-300	23
L		L1121-1H0	13	L1321-100	70	L1612-800	23
		L1122-1E0	13	L1322-100	70	L1620-100	23
L1001-810	5	L1122-1H0	13	L1401-100	19	L1620-300	23
L1001-B10	5	L1123-1H0	13	L1401-B00	19	L1621-100	23
L1002-810	5	L1130-1H0	12	L1402-100	19	L1621-300	23
L1002-B10	5	L1131-1H0	12	L1402-B00	19	L1622-100	23
L1003-810	5	L1132-1H0	12	L1403-100	19	L1622-300	23
L1003-B10	5	L1133-1H0	12	L1403-B00	19	L1630-300	23
L1004-B10	7	L1134-1H0	12	L1404-100	19	L1630-800	23
L1005-810	6	L1135-1H0	12	L1404-B00	19	L1631-300	23
L1005-B10	6	L1140-BH0	14	L1405-100	19	L1631-800	23
L1006-B10	7	L1141-BH0	14	L1405-B00	19	L1632-300	23
L1007-B10	8	L1142-BH0	14	L1406-100	19	L1632-800	23
L1010-810	5	L1150-0H0	17	L1406-B00	19	L1660-300	23
L1010-B10	5	L1151-0H0	17	L1410-100	20	L1660-800	23
L1011-810	5	L1160-FH0	14	L1410-B00	20	L1661-300	23
L1011-B10	5	L1160-GE0	14	L1411-100	20	L1661-800	23
L1012-810	6	L1160-GH0	14	L1411-B00	20	L1662-300	23
L1012-B10	6	L1161-FH0	14	L1412-100	20	L1662-800	23
L1013-B10	8	L1161-GH0	14	L1412-B00	20	L1670-900	22
L1014-810	6	L1162-FH0	15	L1420-100	20	L1671-900	22
L1014-B10	6	L1162-GH0	15	L1420-B00	20	L1680-300	22
L1015-B10	7	L1170-FH0	15	L1421-100	20	L1680-800	22
L1016-B10	8	L1170-GH0	15	L1421-B00	20	L1681-300	22
L1020-810	7	L1171-FH0	15	L1501-300	21	L1681-800	22
L1020-B10	7	L1171-GH0	15	L1503-8E0	21	L1701-1E5	27
L1030-B10	7	L1172-GH0	15	L1601-100	22	L1701-3E5	27
L1031-810	6	L1210-CF0	17	L1601-300	22	L1701-5E5	27

CLAVES

CLAVE	PÁGINA	CLAVE	PÁGINA	CLAVE	PÁGINA	CLAVE	PÁGINA
L1702-1E5	27	L1754-800	32	L1833-300	37	L1918-B10	41
L1702-3E5	27	L1754-B00	32	L1833-800	37	L1918-BF0	41
L1702-5E5	27	L1755-100	32	L1842-100	37	L1919-BF0	41
L1703-1E5	27	L1760-100	33	L1842-300	37	L1920-110	42
L1703-3E5	27	L1760-800	33	L1842-800	37	L1920-1G0	42
L1703-5E5	27	L1760-B00	33	L1843-100	37	L1921-110	42
L1704-1E5	27	L1761-100	33	L1843-300	37	L1921-1G0	42
L1710-1E5	27	L1761-300	33	L1843-800	37	L1921-3G0	42
L1710-3E5	27	L1762-100	33	L1850-110	36	L1922-110	43
L1711-1E5	28	L1764-100	33	L1902-1F0	39	L1922-1G0	43
L1711-3E5	28	L1764-800	33	L1910-1F0	39	L1922-B10	43
L1720-1E5	28	L1764-B00	33	L1911-110	39	L1922-BG0	43
L1721-1E5	28	L1765-100	34	L1911-1F0	39	L1923-1G0	42
L1722-1E5	29	L1767-100	34	L1911-1G0	39	L1924-110	43
L1723-1E5	28	L1771-100	31	L1911-3F0	39	L1924-1G0	43
L1730-1E5	29	L1772-100	31	L1911-3G0	39	L1925-B10	43
L1731-1E5	29	L1772-800	31	L1912-110	39	L1925-BG0	43
L1731-3E5	29	L1773-100	31	L1912-1F0	39	L1925-CG0	43
L1731-8E5	29	L1773-B00	31	L1912-1G0	39	L1930-1F0	43
L1732-1E5	29	L1774-100	31	L1914-F10	41	L1931-110	44
L1732-3E5	29	L1774-800	31	L1914-FF0	41	L1931-1F0	44
L1732-8E5	29	L1774-B00	31	L1914-G10	41	L1932-1F0	44
L1740-1E0	30	L1782-100	32	L1914-GF0	41	L1933-B10	44
L1740-3E0	30	L1782-800	32	L1915-110	42	L1933-BF0	44
L1740-5E0	30	L1801-1E0	34	L1915-1F0	42	L1934-1F0	44
L1741-1E0	30	L1801-3E0	34	L1915-1G0	42	L1935-110	45
L1741-3E0	30	L1801-8E0	34	L1915-BF0	42	L1935-1F0	45
L1741-5E0	30	L1802-1E0	34	L1915-BG0	42	L1936-BF0	45
L1742-1E0	30	L1810-1E0	35	L1916-110	40	L1943-1F0	46
L1742-3E0	30	L1810-3E0	35	L1916-1F0	40	L1944-1F0	46
L1742-5E0	30	L1810-8E0	35	L1916-1G0	40	L1945-110	46
L1743-1E0	30	L1811-1E0	35	L1916-3F0	40	L1945-1F0	46
L1743-5E0	30	L1820-100	35	L1917-B10	40	L1946-1F0	46
L1744-1E0	30	L1820-300	35	L1917-BF0	40	L1947-1F0	47
L1750-100	31	L1821-100	35	L1917-BG0	40	L1947-1G0	47
L1750-800	31	L1821-300	35	L1917-CF0	40	L1948-110	47
L1750-B00	31	L1832-100	36	L1917-CG0	40	L1948-1F0	47
L1751-100	32	L1832-300	36	L1917-D10	40	L1948-1G0	47
L1753-100	32	L1832-800	36	L1917-DF0	40	L1950-1F0	45
L1754-100	32	L1833-100	37	L1917-DG0	40	L1951-110	45



CLAVE	PÁGINA	CLAVE	PÁGINA	CLAVE	PÁGINA	CLAVE	PÁGINA
L1951-1F0	45	L2122-1F0	53	L2182-1F0	59	L2304-2J0	67
L1951-1G0	45	L2122-1G0	53	L2182-1G0	59	L2305-2F0	65
L1952-B10	46	L2122-1J0	53	L2183-1F0	60	L2305-2G0	65
L1952-BF0	46	L2123-1F0	53	L2183-1G0	60	L2306-2F0	67
L1953-1F0	46	L2123-1G0	53	L2184-1F0	60	L2306-2G0	67
L1980-110	47	L2123-1J0	53	L2184-1G0	60	L2310-2F0	68
L1980-1F0	47	L2130-EF0	54	L2185-1F0	60	L2310-2G0	68
L1980-1G0	47	L2131-EF0	54	L2185-1G0	61	L2311-2F0	68
L1981-110	47	L2132-EF0	54	L2186-1F0	61	L2311-2G0	68
L1981-1F0	47	L2133-EF0	54	L2190-1F0	61	L2312-2F0	68
L1981-1G0	47	L2133-EG0	54	L2190-1G0	61	L2312-2G0	68
L2001-800	49	L2140-5F0	55	L2191-1F0	60	L2313-2F0	68
L2002-1G0	49	L2140-5G0	55	L2191-1G0	60	L2313-2G0	68
L2003-100	49	L2143-5G0	56	L2192-1F0	61	L2320-1F0	69
L2004-100	49	L2144-5F0	56	L2192-1G0	61	L2330-3F0	69
L2004-800	49	L2144-5G0	56	L2193-1F0	61	L2331-3F0	69
L2005-100	49	L2145-5F0	55	L2193-1G0	61	L2340-1F0	69
L2006-100	49	L2145-5G0	55	L2194-1F0	61	L2350-1F0	69
L2006-800	49	L2150-5F0	56	L2194-1G0	61	L2351-1F0	69
L2007-B00	49	L2150-5G0	56	L2195-1F0	61	L2360-3F0	69
L2008-1G0	49	L2151-5G0	56	L2195-1G0	61	L2601-5F0	71
L2014-6G0	49	L2160-1F0	57	L2201-6G0	62	L2601-5G0	71
L2104-1F0	50	L2160-5F0	57	L2202-6G0	62	L2602-5F0	71
L2104-1G0	50	L2162-1F0	57	L2204-6G0	63	L2603-5F0	71
L2105-1F0	50	L2170-1F0	57	L2210-1G0	63	L2603-5G0	71
L2105-1G0	50	L2170-1G0	57	L2210-3G0	63	L2605-5F0	71
L2106-1F0	50	L2171-1F0	57	L2211-1G0	63	L2605-5G0	71
L2106-1G0	50	L2171-1G0	57	L2211-3G0	63	L2606-5F0	71
L2110-1F0	51	L2172-1F0	57	L2212-1G0	63	L2607-5F0	71
L2110-1G0	51	L2172-1G0	57	L2212-3G0	63	L2607-5G0	71
L2111-1F0	51	L2175-1F0	58	L2213-1G0	63	L2608-5F0	71
L2111-1G0	51	L2176-1F0	58	L2301-2F0	67	L2608-5G0	71
L2112-1F0	51	L2176-5F0	58	L2301-2G0	67	L2610-1F0	72
L2112-1G0	51	L2177-1F0	58	L2302-2F0	67	L2610-1G0	72
L2113-1F0	51	L2177-1G0	58	L2302-2G0	67	L2611-1F0	72
L2113-1G0	51	L2178-1F0	58	L2303-2F0	67	L2611-1G0	72
L2120-1F0	52	L2180-1F0	59	L2303-2G0	67	L2612-1F0	72
L2120-1G0	52	L2180-1G0	59	L2303-2J0	67	L2612-1G0	72
L2121-1F0	52	L2181-1F0	59	L2304-2F0	67	L2613-1F0	72
L2121-1G0	52	L2181-1G0	59	L2304-2G0	67	L2613-1G0	72

CLAVES

CLAVE	PÁGINA	CLAVE	PÁGINA	CLAVE	PÁGINA
L2620-1F0	73	P0009-000	93	P0190-000	91
L2620-1G0	73	P0010-000	93	P0190-100	91
L2621-1F0	73	P0011-000	93	P0191-000	91
L2621-1G0	73	P0013-000	95	P0191-100	91
L2622-1F0	73	P0029-000	93	P0217-000	92
L2622-1G0	73	P0030-000	94	P0246-000	94
L2623-1F0	73	P0039-000	93	P0263-000	95
L2623-1G0	73	P0040-000	94	P0263-000	95
L2624-1F0	73	P0041-000	93		
L2624-1G0	73	P0042-000	93	R	
L2625-1F0	73	P0051-000	92		
L2625-1G0	73	P0058-000	95	R1001-000	92
L2626-1F0	73	P0059-000	95	R1002-000	92
L2626-1G0	73	P0071-000	94	R1003-000	92
L2701-110	9	P0088-000	95	R1003-100	92
L2701-910	9	P0088-000	95	R1004-000	92
L2701-B10	9	P0090-000	94	R1004-100	92
L2701-G10	9	P0095-000	93	R1005-000	92
L2702-110	9	P0097-000	93	R1005-100	92
L2702-910	9	P0098-000	93	R1006-000	92
L2702-B10	9	P0103-000	93	R1006-100	92
L2702-G10	9	P0108-000	93		
L2703-110	9	P0109-000	93		
L2703-910	9	P0117-000	93		
L2703-B10	9	P0118-000	93		
L2703-G10	9	P0120-000	95		
L2704-110	9	P0137-000	91		
L2710-G10	10	P0137-100	91		
L2711-G10	10	P0139-000	95		
L2720-G10	10	P0141-000	95		
L2721-910	10	P0146-300	91		
L2730-G00	11	P0146-500	91		
L2731-G00	11	P0160-500	91		
L2732-G00	11	P0161-400	91		
		P0161-500	91		
		P0161-600	91		
		P0162-500	91		
P		P0175-000	94		
P0001-000	94	P0181-000	91		
P0007-000	95	P0181-100	91		

MAGG se reserva el derecho de modificar la información contenida en este catálogo sin previo aviso y no se hace responsable por errores u omisiones de este documento.



CENTRO DE VENTA Y MANUFACTURA

San Luis Tlailco No. 30
Col. Parque Industrial Naucalpan
C.P. 53489 Naucalpan, Estado de México
Tel.: (55) 5300 0646
Fax: (55) 5300 6965
email: magg@electromag.com.mx
www.magg.com.mx

PUEBLA

30 Norte No. 604 Bodega 20, entre calles
6 y 8 Ote.
Col. Resurgimiento
C.P. 72370 Puebla, Puebla
Tel.: (22) 2236 8222
Fax: (22) 2235 3553
email: pue@electromag.com.mx

MONTERREY

General Manuel M. González No. 1303
Col. Niño Artillero
C.P. 64280 Monterrey, Nuevo León
Tel.: (81) 8351 8441
Fax: (81) 8351 0392
email: mty@electromag.com.mx

MÉXICO, D.F.

Victoria No. 32-101
Col. Centro
C.P. 06050 México, D.F.
Tel.: (55) 5518 4599
Fax: (55) 5512 3771
email: vic@electromag.com.mx

GUADALAJARA

Calle Primavera No. 2470
Col. Fresno Poniente
C.P. 44900 Guadalajara, Jalisco
Tel./Fax: (33) 3811 4722
email: gdl@electromag.com.mx

MÉRIDA

Calle 23 No. 391, entre 48 y 50
Col. Ampliación Ciudad Industrial, Paseos
de Itzincab
C.P. 97392 Umán, Yucatán
Tel.: (99) 9919 1537
email: med@electromag.com.mx

QUERÉTARO

Piríneos No. 515 Bodega 14
Micro Parque Industrial Santiago
Col. Parque Industrial Benito Juárez
C.P. 76120 Querétaro, Querétaro
Tel.: (44) 2210 2090
Fax: (44) 2182 2762
email: qro@electromag.com.mx